

Pro

ETIC

MADE IN ITALY. MADE TO EXCEL.

WELLNESS



atlas concorde



Atlas Concorde is a global specialist in premium porcelain and wall tiles for every style and application in residential, commercial and public architecture. Being global specialists means excellence in the level of design and technology in each type of surface, making it possible to always offer designers and end users the best solution for each application.

Atlas Concorde è specialista globale in superfici ceramiche d'eccellenza per ogni stile e applicazione nell'architettura residenziale, commerciale e pubblica. Essere specialisti globali significa eccellere per livello di design e tecnologia in ciascun tipo di superficie, così da offrire sempre ai progettisti e agli utilizzatori finali la soluzione migliore per ogni applicazione.

www.atlasconcorde.com

WOOD LOOK

COLOURED BODY
PORCELAIN TILES
GRES PORCELLANATO
COLORATO IN MASSA
Grès cérame coloré
dans la masse
Durchgefärbtes
Feinsteinzeug
Gres porcelánico
coloreado en masa
Керамический гранит
окрашенный в массе



ETIC Pro
PRESTIGIOUS AND ORIGINAL CHARACTER



NATURAL WOOD INSPIRATION FOR PROJECTS OF PURE DESIGN

*Ispirazione legno naturale
per progetti di puro design*

The marked character of original and prestigious wood essences breathes new life on the surface of extremely natural and elegant porcelain tiles, for indoor and outdoor areas with cutting edge design. With a pleasant sense of motion, the surface is characterised by outstanding graphic depth that evokes, with extraordinary realism and authenticity, the alluring details of original planks of wood.

La personalità incisiva di originali e prestigiose essenze legno vive sulla superficie di un gres porcellanato estremamente naturale ed elegante, per interni ed esterni dal design attuale. Gradevolmente mossi, la superficie è caratterizzata da una straordinaria profondità grafica che evoca con realismo estremo e autenticità i suggestivi dettagli di inedite tavole legno.



INSPIRATION AU BOIS NATUREL POUR DES PROJETS PUR DESIGN

La personnalité incisive des originales et prestigieuses essences de bois anime la surface d'un grès cérame extrêmement naturel et élégant, pour des intérieurs et extérieurs au design actuel. Agréablement animée, la surface est caractérisée par une extraordinaire profondeur graphique qui évoque avec un réalisme et une authenticité extrêmes les détails suggestifs de planches en bois inédites.

INSPIRATION NATURHOLZ FÜR PROJEKTE IN PUREM DESIGN

Der prägnante Charakter von kostbaren Holzarten lebt auf den äußerst natürlichen und eleganten Feinsteinzeugoberflächen auf, für Innen- und Außenbereiche in aktuellem Design. Angenehm bewegt, die Oberfläche kennzeichnet sich durch eine außergewöhnliche Tiefe der Grafiken und bildet mit extremen Realismus und Authentizität die stimmungsvollen Details von Holzbrettern wieder.

INSPIRACIÓN MADERA NATURAL PARA PROYECTOS DE PURO DISEÑO

La personalidad incisiva de originales y prestigiosas maderas vive en la superficie de un gres porcelánico extremadamente natural y elegante, para interiores y exteriores de diseño actual. Agradablemente ondulada, la superficie se caracteriza por una extraordinaria profundidad gráfica que evoca con realismo extremo y autenticidad los sugerentes detalles de inéditas tablas de madera.

КРАСОТА НАТУРАЛЬНОГО ДЕРЕВА ДЛЯ СОВРЕМЕННЫХ ДИЗАЙНЕРСКИХ ПРОЕКТОВ

Яркий характер элитных пород древесины оживает на элегантной керамогранитной плитке для современных внутренних и наружных пространств. Поверхность плиток отличается приятным динамизмом и удивительной глубиной рисунка, с предельным реализмом воспроизводящего каждую деталь натуральной деревянной доски.



ELEGANT AND NATURAL WOOD LOOK FOR CONTEMPORARY PROJECTS

Eleganza e naturalezza effetto legno per progetti contemporanei

The naturalness of precious untreated wood comes to life in a matt surface with a soft touch characterised by light micro-textures so typical of the natural material of inspiration. With a strong substantial appeal, rich in knots, veining and reliefs, the precious wood look porcelain tile surfaces perfectly clad outdoor areas blending aesthetics, safety and functionality.

La naturalezza del legno pregiato non trattato rivive in una superficie matt dalla mano morbida attraversata da leggere microstrutture tipiche della materia di riferimento. Fortemente materiche, ricche di nodi, venature e rilievi, le pregiate superfici effetto legno in gres porcellanato conquistano gli spazi esterni contemporanei, integrando risultato estetico, sicurezza e praticità.



L'ÉLÉGANCE ET LA NATURALITÉ DE L'IMITATION BOIS POUR DES PROJETS CONTEMPORAINS

Le caractère naturel du bois précieux non traité revêt dans une surface mate au doux toucher, sillonnée par de légères microstructures typiques de la matière de référence. Intensément texturées, riches en nœuds, veines et reliefs, les précieuses surfaces en grès cérame imitation bois enchantent les espaces extérieurs contemporains, en y intégrant le résultat esthétique, la sécurité et la praticité.

ELEGANZ UND NATURHOLZEFFEKT FÜR ZEITGENÖSSISCHE PROJEKTE

Die Natürlichkeit von edlem unbehandeltem Holz lebt in einer äußerst weichen, matten Oberfläche mit leichten Mikrostrukturen, wie sie die Vorlage aufweist, wieder auf. Starke Materie, voller Knoten, Adern und mit erhabenen Strukturen erobert das Feinsteinzeug mit Holz-Optik moderne Außenräume und vereint Ästhetik, Sicherheit und Funktionalität.

ELEGANCIA Y NATURALIDAD EFECTO MADERA PARA PROYECTOS CONTEMPORÁNEOS

La naturalidad de la madera valiosa no tratada revive en una superficie opaca de mano suave atravesada por ligeras microestructuras típicas del material de referencia. Decididamente materiales, ricos de nudos, vetas y relieves, las valiosas superficies efecto madera en gres porcelánico conquistan los espacios exteriores contemporáneos, integrando resultado estético, seguridad y practicidad.

ЭЛЕГАНТНОСТЬ И НАТУРАЛЬНОСТЬ ДРЕВЕСНОГО РИСУНКА ДЛЯ СОВРЕМЕННЫХ ПРОЕКТОВ

Натуральность благородной необработанной древесины оживает в мягкой матовой поверхности с такой же микроструктурой, как у исходного природного материала. Богатый узлами, прожилками и рельефами «древесный» керамогранит стильно вписывается в наружные пространства, соединяя эстетическую привлекательность, безопасность и практичность.

Q

Functionality, resistance, wood look in the outdoors: LASTRA 20mm

Funzionalità, resistenza, estetica effetto legno in outdoor: LASTRA 20mm

Fonctionnalité, résistance, esthétique imitation bois à l'extérieur : LASTRA 20mm. **Funktionalität, Strapazierfähigkeit, ästhetische Holz-Optik im Außenbereich: LASTRA 20mm.** Funcionalidad, resistencia, estética efecto madera en exteriores: LASTRA 20mm. **Функциональность, стойкость, красота дерева в наружных пространствах: LASTRA 20mm.**



**ROVERE VENICE
MAJESTIC
BEAUTY**

UNE SÉLECTION PRÉCIEUSE DE SURFACES IMITATION BOIS
 Une sélection minutieuse d'essences de bois, précieuses et originales, interprète l'intense caractère naturel de quatre planches d'inspiration variée. La richesse des détails souligne la préciosité des bois de référence, pour un grès cérame imitation bois fiable, résistant et de grand impact.

UNA VALIOSA SELECCIÓN DE SUPERFICIES EFECTO MADERA
 Una cuidadosa selección de valiosísimas y originales maderas interpreta la intensa naturalidad de cuatro tablas de diferente inspiración. La riqueza de detalles evidencia el valor de las maderas de referencia, para conseguir un gres porcelánico efecto madera fiable, resistente y de gran impacto.

EINE FEINE AUSWAHL AN OBERFLÄCHEN MIT HOLZ-OPTIK
 Eine sorgfältige Auswahl sehr wertvoller und ursprünglicher Holzarten interpretiert die intensive Natürlichkeit der Holzbretter der vier Vorlageholzarten. Der Detailreichtum betont den Wert des Holzes der Vorlage, für ein Feinsteinzeug mit Holz-Optik zuverlässig, langlebig und mit großer Wirkung.

ЦЕННАЯ КОЛЛЕКЦИЯ ПОВЕРХНОСТЕЙ, ИМИТИРУЮЩИХ ДЕРЕВО
 В аккуратном подборе фактур отражена насыщенная натуральность четырех разных пород древесины. Благородный древесный рисунок стильно выступает на поверхности стойкого, прочного, безопасного по характеристикам керамогранита.



**NOCE HICKORY
NATURAL
CHARM**

**A PRECIOUS
SELECTION
OF WOOD
LOOK
SURFACES**

Una pregiata selezione di superfici effetto legno

A careful selection of precious and original wood essences interpret intense the natural appeal in four wood look planks of different inspiration. The richness of details underlines the preciousness of the natural wood in reliable, resistant porcelain tiles of tremendous appeal.

Un'accurata selezione di pregiatissime e originali essenze legno interpreta l'intensa naturalezza di quattro tavole di diversa ispirazione. La ricchezza di dettagli sottolinea il pregio dei legni di riferimento, per un gres porcellanato effetto legno affidabile, resistente e dal forte impatto.



**QUERCIA ANTIQUE
CAPTIVATING
CHARACTER**

Wood look surfaces with energetic naturalness
 Superfici effetto legno dall'energica naturalezza

Des surfaces imitation bois naturellement énergiques.
Oberflächen mit Holz-Optik voller natürlicher Kraft.
 Superficies efecto madera de energética naturalidad.
 Поверхности, имитирующие энергичную натуральность дерева.



**EUCALIPTO SMOKED
CONTEMPORARY
APPEAL**

AVAILABLE SURFACE FINISHES

MATT	GRIP
POLISHED	OUTDOOR PAVING
	LASTRA 20 E



CHARME IMPÉRISSABLE ET TOUCHE DÉCORATIF
Des décorations par découpe, raffinées et actuelles, multiplient la suggestion de l'imitation bois pour un design contemporain, naturellement riche et prestigieux.

ZEITLOSER CHARME UND ORNAMENTALER HAUCH
Erlasene und aktuelle Dekore vervielfachen den Eindruck von Holz für ein zeitgemäßes Design voller Natürlichkeit und Stil.

ENCANTO IMPERECEDERO Y TOQUE DECORATIVO
Decoraciones de corte sofisticadas y actuales multiplican la sugestión del efecto madera para un diseño contemporáneo rico de naturalidad y prestigio.

НЕУВЯДАЕМОЕ ОЧАРОВАНИЕ И ОРНАМЕНТАЛЬНЫЙ ШТРИХ
Благодаря изысканным вырезным декорам, стильно подчеркивающим «древесную» фактуру покрытий, интерьеры выглядят элитно, натурально, современно.



TIMELESS CHARM AND ORNAMENTAL TOUCH

**Intramontabile fascino
e tocco ornamentale**

Sought-after and modern pre-cut decorations multiply the wood look allure for a contemporary design rich in naturalness and prestige.

Decorazioni da taglio ricercate e attuali moltiplicano la suggestione dell'effetto legno per un design contemporaneo ricco di naturalezza e prestigio.





SPACES TO LIVE IN PRESTIGIOUS NATURALNESS

Spazi per vivere in una naturalezza prestigiosa

Irregular dark strips inspired by briar root wood and marked knots run across the expanse of a pleasantly waved wood look porcelain surface that evokes the large planks of American walnut wood softened by the effects of time. The surface that interprets the sought-after details of natural wood with extreme realism is rich in soft veining and enhanced, with intensity, by the large size.

Irregolari striature scure ispirate alla radica e nodi marcati affiorano su una superficie in gres porcellanato effetto legno gradevolmente mossa che evoca grandi tavole di Noce Americano addolcite dallo scorrere del tempo. La superficie, che interpreta con profondo realismo i dettagli ricercati del legno d'origine, è ricca di venature dai movimenti morbidi valorizzati con intensa espressività dal grande formato.

NATURAL CHARM

PROJECT: PRIVATE DWELLING
AREA: RESIDENTIAL INTERIORS

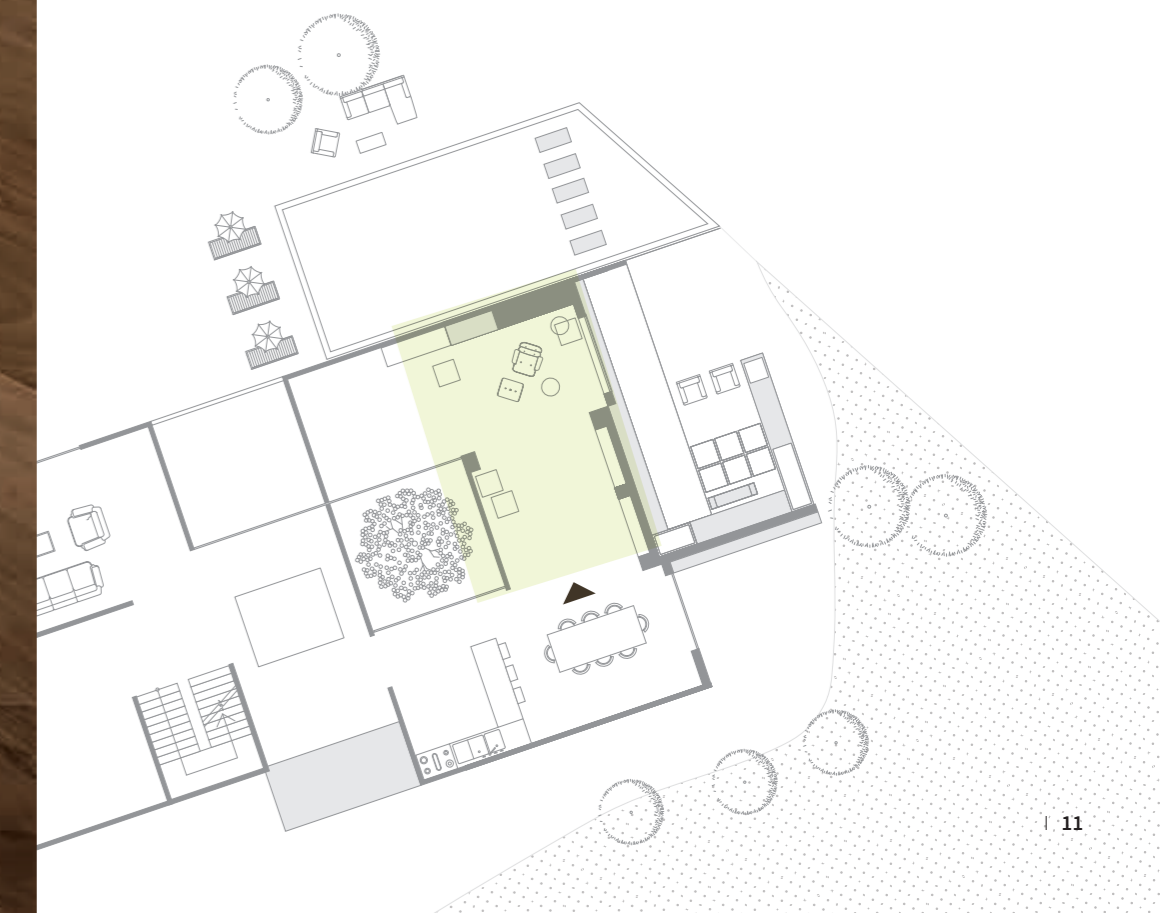

Etic Noce Hickory 25x150 cm
Etic Noce Hickory 15x90 cm
Etic Noce Hickory Chevron 35x34,5 cm
Etic Noce Hickory Tatami 22,5x90 cm

Marvel Crema Delicato Lappato 75x150 cm
Marvel Noir St. Laurent Lappato 60x60 cm

WOOD LOOK PORCELAIN FLOOR
TILES ARE FIRE-PROOF AND DO NOT
WARP DUE TO HEAT.

Il gres porcellanato effetto legno è
ignifugo e non deformabile dal calore.

*Le grès cérame imitation bois est ignifuge et
ne se déforme pas à la chaleur.*

El gres porcelánico efecto madera es ignifugo
y no se deforma a causa del calor.

Das Feinsteinzeug in Holz-Optik ist feuerfest
und verformt sich nicht durch Hitze.

*Керамогранит под дерево огнестоек и не
деформируется под воздействием тепла.*



DES ESPACES POUR VIVRE DANS UN
NATUREL PRESTIGIEUX.

Des stries foncées irrégulières inspirées à
la ronce et des nœuds accentués émergent
sur une surface en grès cérame imitation
bois agréablement animée, qui évoque
les grandes planches de Noyer Américain
adoucies au fil du temps. La surface,
qui interprète les détails raffinés du bois
d'origine avec un réalisme profond, présente
de nombreuses veines sinueuses mises en
valeur grâce à la grande expressivité du
grand format.

**RÄUME FÜR DAS LEBEN IN GEHOBENER
NATÜRLICHKEIT.**

*Unregelmäßige dunkle Rillen inspiriert
durch markante Wurzeln und Knoten
entstehen auf einer Fläche aus
Feinsteinzeug mit angenehm bewegter
Holz-Optik, die an große Bretter aus dem
amerikanischen Nussbaum erinnern,
welche sich mit der Zeit abgenutzt haben.
Die Oberfläche, die mit tiefem Realismus
die raffinierten Details des Holzvorlage
interpretiert, ist reich an sich weich
bewegenden Adern, die vom intensiven
Ausdruck des Großformats betont werden.*

ESPACIOS PARA VIVIR CON NATURALEZA
PRESTIGIOSA.

Irregulares estrias oscuras inspiradas en la
raíz de nogal y nudos marcados afloran
sobre una superficie en gres porcelánico
efecto madera agradablemente ondulada
que evoca grandes tablas de nogal
suavizadas por el pasar del tiempo. La
superficie, que interpreta con profundo
realismo los detalles sofisticados de la
madera original, es rica de vetas de
movimientos suaves valorizados con intensa
expresividad por el gran formato.

**НАТУРАЛЬНЫЕ ПРОСТРАНСТВА ДЛЯ
ЖИЗНИ.**

*Извилистые темные полосы корневого
капа и выраженные сучки элегантно
выступают на керамогранитной
поверхности, имитирующей потертые
временем доски американского ореха.
Поверхность, с предельным реализмом
воспроизводящая каждую деталь
древесины, богата мягкими прожилками,
подчеркнутыми большим форматом.*



CHEVRONDECOR

Characterised by a prestigious herringbone patterns that recalls the floors of the European homes of an age gone by.

Caratterizzato da una posa a lisca di pesce dall'aspetto prestigioso richiama i pavimenti delle antiche dimore europee.

Caractérisé par une pose à bâtons rompus d'aspect prestigieux, il rappelle les sols des anciennes demeures européennes.

Caracterizado por una colocación en espina de pez de aspecto prestigioso evoca los pavimentos de las antiguas moradas europeas.

Charakterisiert durch die hochwertige Verlegung im Fischgrätenmuster, die an die Bodenbeläge in den alten Häusern Europas erinnern.

Роскошный рисунок укладки французской елочкой напоминает полы старинных европейских домов.





IMMERSE YOURSELF IN THE RELAXATION OF ENVELOPING NATURAL ATMOSPHERES

Immergersi nel relax di avvolgenti atmosfere naturali

A warm and enveloping wood effect faithfully reinterprets the prestigious details, the deep veins and contrasting knots, inspired by Venetian Briccole. A porcelain slab with a soft, natural touch faithfully reproduces richness, graphic variability and irregularity of the surface of untreated wood.

Un effetto legno caldo e avvolgente interpreta fedelmente i dettagli prestigiosi, le venature profonde e i nodi a contrasto ispirati alle Briccole veneziane. Un gres porcellanato dalla mano morbida profondamente naturale riproduce la ricchezza, la variabilità grafica e le irregolarità di superficie del legno non trattato.

MAJESTIC BEAUTY

PROJECT: SPA RESORT

AREA: WELLNESS&RELAXATION

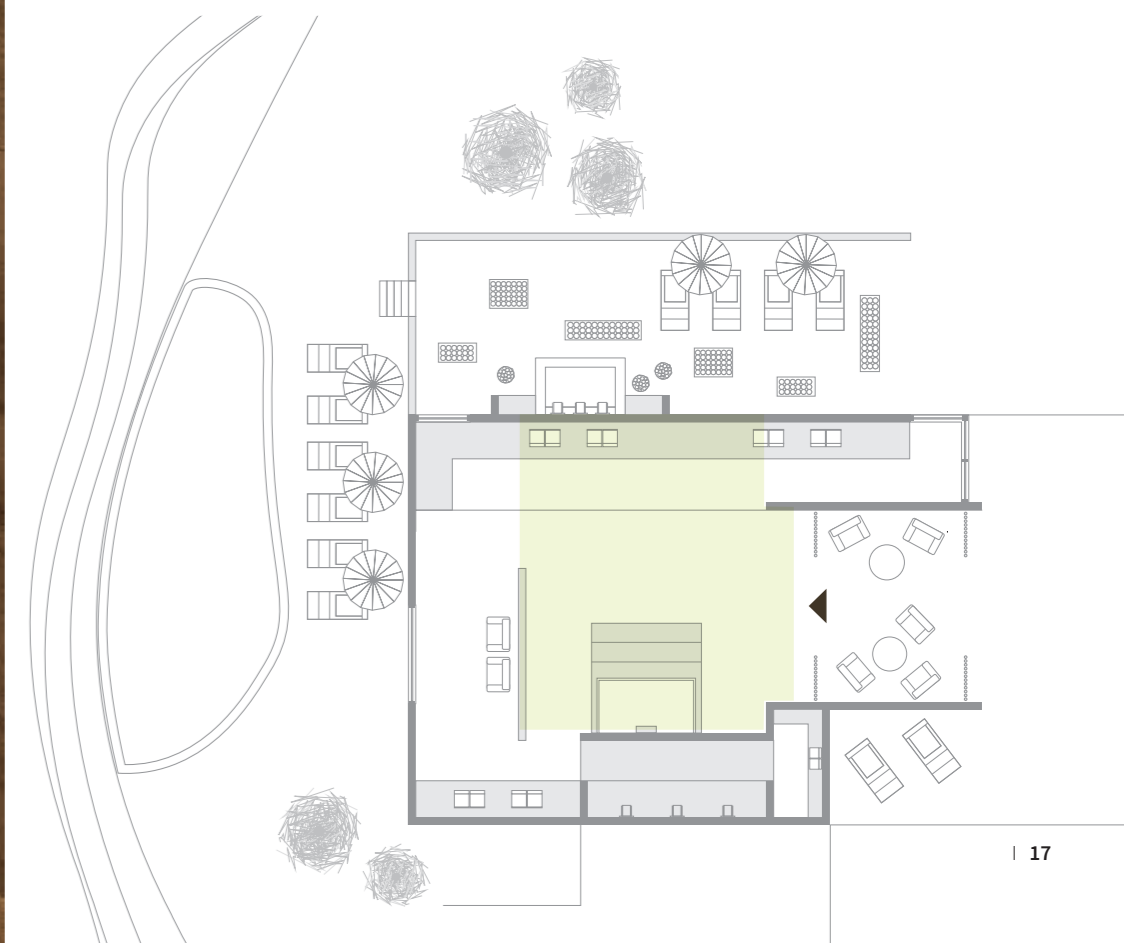

Etic Rovere Venice 25x150 cm
Etic Rovere Venice Herringbone 36,2x41,2 cm

Marvel Grey Fleury Strutturato 30x60 cm

PLONGER DANS LA DÉTENTE
D'ATMOSPHÈRES NATURELLES ET
ENVELOPPANTES.

L'imitation bois chaude et enveloppante
interprète fidèlement les prestigieux détails,
les profondes veines et les nœuds en
contraste inspirés aux Briccole vénitiennes.
Un grès cérame doux au toucher et
profondément naturel reproduit la richesse,
la variabilité graphique et les aspérités de
surface du bois non traité.

**EINGETAUCHT IN DIE ENTSPANNUNG
NATÜRLICHER ATMOSPHEREN.**

*Die warme und behagliche Holz-Optik
bildet naturgetreu die kostbaren Details,
die tiefen Adern und die kontrastreichen
Knoten der venezianischen Briccole, der
Eichenpfähle, nach. Ein Feinsteinzeug mit
weicher Optik, natürlich tief, bildet den
Reichtum, die graphische Variabilität und
die Unregelmäßigkeiten der Oberfläche von
unbehandeltem Holz nach.*

SUMERGIRSE EN LA RELAJACIÓN DE
ENVOLVENTES ATMÓSFERAS NATURALES.

Un efecto madera cálida y envolvente
interpreta fielmente los detalles valiosos,
las vetas profundas y los nudos en
contraste inspirados en los duques de Alba
venecianos. Un grés porcelánico de mano
suave profundamente natural reproduce
la riqueza, la variabilidad gráfica y las
irregularidades de superficie de la madera
no tratada.

ПОГРУЖЕНИЕ В РЕЛАКСИРУЮЩУЮ
НАТУРАЛЬНУЮ АТМОСФЕРУ.

*Теплая древесная фактура реалистично
имитирует детали, глубокие прожилки,
контрастные сучки венецианских
причальных палов. Глубоко натуральный
и мягкий на ощупь керамогранит с
точностью воспроизводит богатство
рисунка и естественные неровности
необработанной древесины.*



WOOD LOOK PORCELAIN SLABS ENSURE HIGH RESISTANCE TO WATER AND MOISTURE.

Il gres porcellanato effetto legno assicura un'elevata resistenza all'acqua e all'umidità.

Le grès cérame imitation bois garantit une haute résistance à l'eau et à l'humidité.

El gres porcelánico efecto madera asegura una elevada resistencia al agua y a la humedad.

Das Feinsteinzeug in Holz-Optik sorgt für eine hohe Beständigkeit gegenüber Wasser und Feuchtigkeit.

Керамогранит под дерево стоек к воде и влаге.



HERRINGBONEDECOR

A modern decor made up of perpendicular listels to create the timeless Italian herringbone pattern.

Moderno decoro composto da listelli perpendicolari per l'intramontabile posa a spina di pesce italiana.

Le décor moderne composé de lames perpendiculaires pour l'éternelle pose à bâtons rompus italienne.

Moderna decoración compuesta por listones perpendiculares para la imperecedera colocación en espina de pez italiana.

Das moderne Dekor besteht aus senkrechten Leisten für eine zeitlose Verlegung im Fischgrätenmuster.

Современный декор из перпендикулярных планок для элегантной укладки итальянской елочкой.



GARDEN SPA

A porcelain tile surface of 2 cm thickness effortlessly expresses with naturalness and realism the warmth of wood, to create coordinated projects that link the inside and outside. The 30x120 format enhances the aesthetics of the natural material of inspiration.

Una superficie in gres porcellanato di spessore 2 cm esprime con naturalezza e realismo il calore dell'effetto legno, per dare vita a progetti coordinati tra interno ed esterno. Il formato 30x120 valorizza l'estetica del materiale naturale d'ispirazione.

MAJESTIC BEAUTY

PROJECT: SPA RESORT
AREA: OUTDOOR RELAXATION

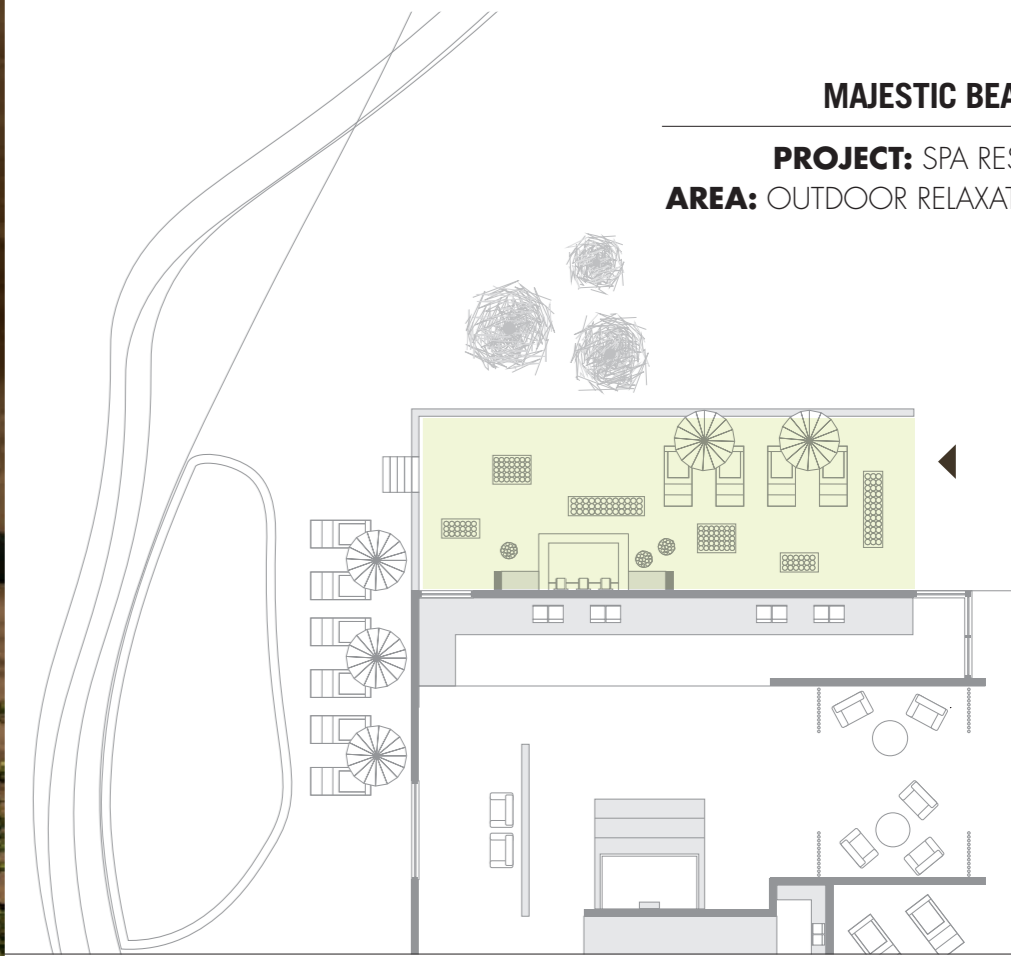

Une surface en grès cérame de 2 cm d'épaisseur exprime avec naturel et réalisme la chaleur de l'imitation bois, pour créer des projets coordonnés entre l'intérieur et l'extérieur. Le format 30x120 exalte l'esthétique de la matière naturelle d'inspiration.

Eine Oberfläche aus Feinsteinzeug in einer Stärke von 2 cm erzeugt ganz natürlich und realistisch die warme Wirkung von Holz, um aufeinander abgestimmte Projekte in Innen- und Außenbereichen zu gestalten. Das Format 30x120 bringt die Ästhetik des Materials der Vorlage zur Geltung.

Una superficie en gres porcelánico de 2 cm de espesor expresa con naturalidad y realismo el calor del efecto madera, para dar vida a proyectos con interiores y exteriores coordinados. El formato 30x120 valoriza el aspecto estético del material natural de inspiración.

Керамогранитные покрытия толщиной 2 см с предельным реализмом передают живое тепло дерева, позволяя гармонично оформлять внутренние и наружные пространства в едином стиле. Формат 30x120 эффектно подчеркивает рисунок исходного природного материала.

- Etic Rovere Venice 25x150 cm
- Etic Rovere Venice LASTRA 20mm 30x120 cm
- Etic Rovere Venice Chevron Tatami 74x22,2 cm
- Marvel Grey Fleury Strutturato 30x60 cm



**THE VERSION IN 2 CM THICKNESS
GUARANTEES CONSIDERABLE MECHANICAL
STRENGTH.**

La versione con spessore 2 cm garantisce una notevole resistenza meccanica.

La version en 2 cm d'épaisseur garantit une résistance mécanique remarquable.

La versione de 2 cm de espesor garantiza una notable resistencia mecánica.

Die Version in einer Stärke von 2 cm gewährleistet eine beachtliche mechanische Festigkeit.

Вариант толщиной 2 см обеспечивает высокую механическую стойкость покрытий.



CHEVRON TATAMIDECOR

A touch of sought-after modernity highlights the classically inspired herringbone pattern.

Un tocco di ricercata modernità attualizza la posa a spina di pesce di ispirazione classica.

Une touche de modernité raffinée rénove la pose à bâtons rompus de style classique.

Un toque de sofisticada modernidad actualiza la colocación en espina de pez de inspiración clásica.

Ein Hauch von erlesener Modernität aktualisiert die klassische Verlegung von Fußböden im Fischgrätenmuster.

В классическом елочном рисунке укладки просматривается изысканная современная нотка.





TASTE EXPERIENCE IN SPACES WITH DESIGN IMPACT

Esperienza di gusto in spazi dal design d'impatto

Sapwood of the utmost vigour trace defined and innovative colour contrasts on the surface in wood look porcelain tiles inspired by age-old Italian oak, boldly highlighting modern design spaces. Soft, natural and full of delicate micro-reliefs, the matt surface emphasizes the special details inspired by prestigious and original wooden essences, for interior design projects of absolute visual impact.

Alburni dalla vitalità intensa delineano netti e originali contrasti cromatici sulla superficie in gres porcellanato effetto legno ispirata alla Quercia secolare italiana, sottolineando con decisione spazi dal design attuale. Morbida, naturale e ricca di delicati microrilievi, la superficie matt enfatizza i dettagli ricercati ispirati a prestigiose e originali essenze legno, per progetti di interior design di assoluto impatto visivo.

CAPTIVATING CHARACTER

PROJECT: RESTAURANT&CAFÈ

AREA: FOOD&DRINK CAFÈ

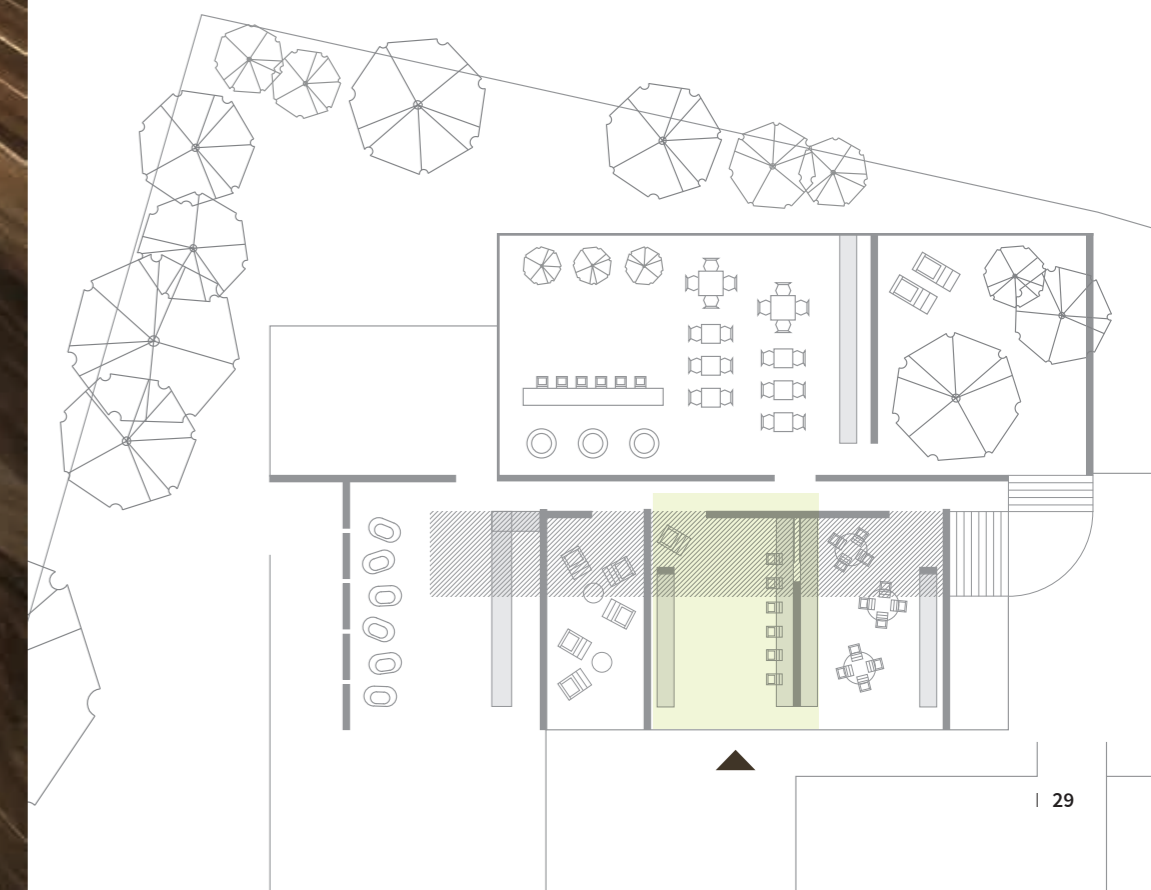

Etic Quercia Antique 25x150 cm
Etic Quercia Antique Industrial 3D 44x28,5 cm
Mark Chrome 75x150 cm

UNE EXPÉRIENCE DE GOÛT DANS DES ESPACES AU DESIGN D'IMPACT.

Des Aubiers d'une vitalité intense définissent des contrastes chromatiques nets et originaux sur la surface en grès cérame imitation bois, inspirée au Chêne séculaire italien, en soulignant avec rigueur des espaces au design actuel. Souple, naturelle et riche en microreliefs délicats, la surface mate exalte les détails raffinés inspirés aux prestigieuses et originales essences de bois, pour des projets de design d'intérieur de très grand impact visuel.

KULINARISCHE ERLEBNISSE IN AUSDRUCKSSTARKEN DESIGNERRÄUMEN.

Splintholz von intensiver Vitalität sorgt für klare und ursprüngliche Farbkontraste auf der Oberfläche des Feinsteinzeugs in Holz-Optik, das durch jahrhundertalte italienische Eichen inspiriert ist und bringt Räume in aktuellem Design zur Geltung. Weich, natürlich und übersät mit leichten Erhebungen, die matte Oberfläche betont die raffinierten Details von kostbaren und ursprünglichen Hölzern, für Innenarchitektur-Projekte von absoluter ästhetischer Wirkung.

EXPERIENCIA DE BUEN GUSTO EN ESPACIOS DE DISEÑO IMPACTANTE.

Alburnos de vitalidad intensa delinean netos y originales contrastes cromáticos en la superficie de gres porcelánico efecto madera inspirada en el roble secular italiano, destacando decididamente los espacios de diseño actual. Suave, natural y rica de delicadas microestructuras, la superficie opaca enfatiza los sofisticados detalles inspirados en valiosas y originales maderas, para proyectos de diseño de interiores de impactico visual absoluto.

ОТДЫХ СО ВКУСОМ В КРАСИВЫХ ИНТЕРЬЕРАХ.

Живая структура заболони образует на «дубовом» керамограните оригинальные цветовые контрасты, благодаря которым интерьер приобретает стильный современный вид. Матовая, натуральная, богатая мягкими микрорельефами поверхность воспроизводит изысканные детали благородных пород дерева, придавая современным интерьерам эффектную стильность.



IT MAINTAINS THE AESTHETICS OF THE SURFACE AND IS NOT SUBJECT TO DIMENSIONAL VARIATIONS OVER TIME; PERFECT FOR COMMERCIAL VENUES.

Mantiene intatta l'estetica di superficie e non subisce variazioni dimensionali nel tempo; ideale anche in ambienti commerciali.

Il maintient l'esthétique de la surface intacte et ne subit aucune variation dimensionnelle dans le temps ; idéal pour des contextes commerciaux.

Mantiene intacto el aspecto estético de la superficie y no sufre variaciones de tamaño a lo largo del tiempo; es también ideal para ambientes comerciales.

Hält die Ästhetik der Oberfläche sowie die Maße im Laufe der Zeit unverändert bei; ideal für Geschäftsambiente.

Керамогранит не меняет со временем внешнего вида и размеров, поэтому идеален также для коммерческих пространств.



INDUSTRIAL 3DDECOR

Inspired by industrial parquet it sets in motion a striking three-dimensional surface of extraordinary richness of colour.

Ispirato al parquet industriale dà vita a una scenografica superficie tridimensionale dalla straordinaria ricchezza cromatica.

Inspiré par le parquet industriel, il crée une surface scénographique tridimensionnelle d'une richesse chromatique extraordinaire.

Inspirado en el parquet industrial da vida a una escenográfica superficie tridimensional de extraordinaria riqueza cromática.

Inspiriert durch Industrieparkett wird eine spektakuläre Oberfläche mit außergewöhnlichem Farbreichtum geschaffen.

Трёхмерный декор, имитирующий индустриальный паркет, характеризуется удивительным цветовым богатством поверхности.



Prestigious wood essences with neat chromatic contrasts of dark and bright shades revive in porcelain tiles of 2cm thickness with a textured, anti-slip surface to dress, with natural power, the design of exteriors guaranteeing the utmost resistance to weather agents, wear and footfall.

Prestigiose essenze legno dai netti contrasti cromatici tra toni chiari e scuri rivivono in un gres porcellanato di spessore 2cm dalla superficie strutturata e antiscivolo, per avvolgere di forza naturale la progettazione degli esterni, garantendo resistenza agli agenti atmosferici, all'usura e al calpestio.

CAPTIVATING CHARACTER

PROJECT: RESTAURANT&CAFÉ
AREA: OUTDOOR LOUNGE

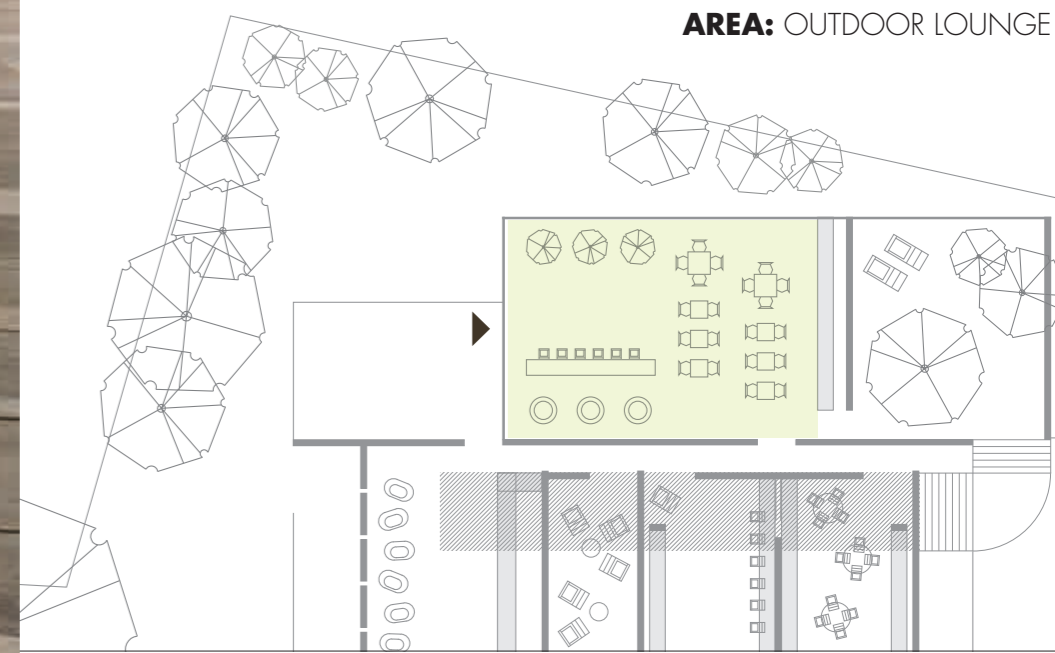

De prestigieuses essences de bois aux contrastes chromatiques nets entre les tons pâles et foncés sont réinterprétées dans un grès cérame de 2 cm d'épaisseur à la surface structurée et antidérapante, pour envelopper d'une force naturelle la conception des extérieurs, tout en garantissant une résistance aux agents atmosphériques, à l'usure et au piétinement.

Kostbare Holzarten mit klaren Kontrasten der hellen und dunklen Töne leben in einem Feinsteinzeug in einer Stärke von 2cm mit strukturierter und rutschfester Oberfläche wieder auf, um Projekte in Außenbereichen mit natürlicher Kraft und einer witterungsbeständigen, verschleiß- und trittfesten Oberfläche zu gestalten.

Valiosas maderas de netos contrastes cromáticos entre tonos claros y oscuros reviven en un gres porcelánico de 2cm de espesor y de superficie estructurada y antideslizamiento, para envolver con fuerza natural la proyección de los exteriores, garantizando resistencia a los agentes atmosféricos, al desgaste y al pisoteo.

Благородные древесные породы с ярко выраженными контрастами светлых и темных волокон оживают в керамогранитной плитке двухсантиметровой толщины со структурной нескользкой поверхностью, обеспечивающей стойкость уличных покрытий к атмосферным воздействиям, износу, пешеходным нагрузкам.

Etic Quercia Antique LASTRA 20mm 30x120 cm
Etic Quercia Antique Tatami 22,5x90 cm

Mark Chrome 75x150 cm
Mark Graphite 75x150 cm



THE 30X120 SIZE IN 2 CM THICKNESS ENHANCES THE NATURAL STREAKS, THE CHROMATIC CONTRASTS AND MICRO-RELIEFS OF THE TEXTURED ANTI-SLIP SURFACE

Il formato 30x120 a spessore 2 cm valorizza le striature naturali, i contrasti cromatici e i microrilievi della superficie strutturata antiscivolo

Le format 30x120 de 2 cm d'épaisseur met en valeur les stries naturelles, les contrastes chromatiques et les microreliefs de la surface structurée antidérapante.

El formato 30x120 de 2 cm de espesor valoriza las estrías naturales, los contrastes cromáticos y los microrelieves de la superficie estructurada antideslizamiento.

Das Format 30x120 in einer Stärke von 2 cm betont die natürlichen Rillen, die Farbkontraste und Mikroprofile der rutschfesten, strukturierten Oberfläche.

Формат 30x120 толщиной 2 см эффектно подчеркивает натуральный рисунок, цветовые контрасты и мягкий микрорельеф нескользкой структурной поверхности.

TATAMIDECOR

Fine listels emphasise the naturalness of the wood look decorating with a minimalist style.

Sottili listelli enfatizzano la naturalezza dell'effetto legno, decorando con stile essenziale.

Des fines lames exaltent le caractère naturel de l'imitation bois, en décorant dans un style essentiel.

Dünne Leisten betonen die Natürlichkeit der Holz-Optik und gestalten die Umgebung mit viel Stil.

Finos listeles enfatizan la naturalidad del efecto madera, decorando con estilo esencial.

Тонкие планки подчеркивают натуральность древесной фактуры, украшая пространства со стильным минимализмом.





ELEGANT CONTEMPORARY SPACES TO LIVE AND WORK

Eleganti spazi contemporanei dove vivere e lavorare

Porcelain surfaces that recall the graphic sophistication and magnetic chromatic energy of Eucalyptus wood and add value to the design of contemporary spaces with elegance and naturalness. The vitality of precious wood, rich in detail converge with the advantages of the best porcelain tiles in terms of strength, durability, ease of maintenance and inalterability.

Superfici in gres porcellanato che ripercorrono la raffinatezza grafica e la magnetica energia cromatica del legno Eucalipto valorizzano il design di spazi contemporanei con eleganza e naturalezza. La vitalità di legni pregiati e ricchi di dettagli incontra i vantaggi del migliore gres porcellanato in termini di resistenza, durezza, semplicità di manutenzione e inalterabilità.

CONTEMPORARY APPEAL

PROJECT: HOME STUDIO
AREA: WORKSPACE HOUSE



Etic Eucalipto Smoked 25x150 cm
Etic Eucalipto Smoked Chevron Tatami 74x22,2 cm
3D/Blade White Matt 40x80 cm

D'ÉLÉGANTS ESPACES CONTEMPORAINS POUR VIVRE ET TRAVAILLER.

Des surfaces en grès cérame qui expriment l'élégance graphique et l'énergie chromatique magnétique du bois Eucalyptus valorisent le design d'espaces contemporains avec élégance et naturel. La vitalité des bois précieux et riches en détails se mêle aux avantages du meilleur grès cérame en termes de résistance, durabilité, simplicité d'entretien et inaltérabilité.

ELEGANTE ZEITGENÖSSISCHE RÄUME ZUM LEBEN UND ARBEITEN.

Oberflächen aus Feinsteinzeug bilden die grafische Raffinesse und die magnetische chromatische Energie von Eukalyptusholz nach und betonen mit Eleganz und Natürlichkeit das Design von modernen Räumen. Die Vitalität von detailreichen, edlen Hölzern trifft auf die Vorteile von bestem Feinsteinzeug in Bezug auf Strapazierfähigkeit, Haltbarkeit, Wartungsfreundlichkeit und Langlebigkeit.

ELEGANTES ESPACIOS CONTEMPORÁNEOS PARA VIVIR Y TRABAJAR.

Superficies en gres porcelánico que proponen el refinamiento gráfico y la magnética energía cromática de la madera de eucalipto valorizan el diseño de espacios contemporáneos con elegancia y naturalidad. La vitalidad de maderas valiosas y ricas de detalles se une a las ventajas del mejor gres porcelánico en términos de resistencia, durabilidad, inalterabilidad y facilidad de manutención.

ЭЛЕГАНТНЫЕ СОВРЕМЕННЫЕ ПРОСТРАНСТВА ДЛЯ ЖИЗНИ И РАБОТЫ.

Керамогранитные поверхности, воспроизводящие изысканный рисунок и притягательные цвета эвкалиптовой древесины, украшают пространства элегантно и натурально. Богатый рисунок ценных пород древесины дополнен лучшими техническими преимуществами керамогранита – стойкостью, прочностью, долговечностью, простотой ухода.



THE NON-ABSORBENT SURFACE AND PORE-FREE AND EASY TO CLEAN AND MAINTAIN.

La superficie non assorbente e priva di pori è semplice da pulire e da mantenere.

La surface n'absorbe pas, et privée de pores, elle résulte simple à nettoyer et à entretenir.

La superficie non assorbente y sin poros es fácil de limpiar y de mantener.

Die nicht-absorbierende, porenfreie Oberfläche ist leicht zu reinigen und zu pflegen.

Беспористая поверхность не поглощает влаги и крайне проста в чистке и уходе.



CHEVRON TATAMIDECOR

Chevron Tatami reinterprets, with a touch of sought-after modernity, a classically inspired herringbone design.

Chevron Tatami interpreta con un tocco di ricercata modernità una spina di pesce d'ispirazione classica.

Chevron Tatami interprète avec une touche de modernité raffinée les bâtons rompus de style classique.

Chevron Tatami interpreta con un toque de sofisticada modernidad una espina de pez de inspiración clásica.

Chevron Tatami interpretiert mit einem Hauch von raffinierter Modernität die klassische Verlegung im Fischgrätenmuster.

Chevron Tatami интерпретирует в современном ключе классический рисунок укладки елочкой.





REFINED AND SUMPTUOUS CONSUMER SPACES

Spazi di consumo dal gusto raffinato e lussuoso

The elegance of the wood resin is brought back to life in Polished porcelain slabs with a shiny and mirrored surface, for luxurious spaces rich class and splendour. The incisive personality, originality and bright character of extremely shiny lapped wood look porcelain slabs perfectly blend with the charm of marble effect surfaces thanks to their intense expressiveness and extraordinary realism.

L'eleganza dei legni resinati rivive in un gres porcellanato lappato dalla superficie lucida e specchiante, per spazi lussuosi ricchi di classe e splendore. La personalità incisiva, l'originalità e il carattere brillante di lucidissimi pavimenti in gres porcellanato effetto legno lappato si sposano al fascino di superfici effetto marmo dall'intensa espressività e dallo straordinario realismo.

LUXURY FASCINATION

PROJECT: EXQUISITE SHOWROOM

AREA: LUXURY CONCEPT STORE

Etic Eucalipto Smoked Lappato 22,5x90 cm

Marvel Statuario Select Macchia Aperta Lappato 75x150 cm

Marvel Statuario Select Lappato 45x90 cm

Marvel Noir St. Laurent Lappato 45x90 cm





DES ESPACES DE CONSOMMATION
D'UN LUXE RAFFINÉ ET SOMPTUEUX.

L'élégance des bois gemmés revit dans un grès cérame adouci à la surface polie et réfléchissante, pour des espaces luxueux, riches en classe et en somptuosité. La personnalité incisive, l'originalité et le caractère brillant des sols polis en grès cérame imitation bois adouci se mêlent au charme de surfaces imitation marbre intensément expressifs et extraordinairement réalistes.

LUXURIÖSE UND RAFFINIERT
KONSUMSTÄTTEN.

Die Eleganz der harzigen Hölzer lebt in einem geläpften Feinsteinzeug mit glänzender und spiegelnder Oberfläche für die Gestaltung von luxuriösen Räumen voller Stil und Pracht wieder auf. Die prägnante Persönlichkeit, Originalität und Charakter des geläpften Feinsteinzeugs mit Holz-Optik kombiniert sich mit dem Charme der Oberflächen mit Marmor-Optik voller intensiver Ausdruckskraft und überraschendem Realismus.

ESPACIOS DE CONSUMO DE LUJO
REFINADO Y Suntuoso.

La elegancia de las maderas resinadas revive en un grés porcelánico lapeado de superficie brillante y reflectante, para espacios lujosos ricos de clase y esplendor. La personalidad incisiva, la originalidad y el carácter brillante de lucentísimos pavimentos de grés porcelánico efecto madera lapeada se conjuntan con el encanto de superficies efecto mármol de intensa expresividad y de extraordinario realismo.

ИНТЕРЬЕРЫ, ПРОНИЗАННЫЕ
ИЗЫСКАННОЙ РОСКОШЬЮ.

Элегантность просмоленного дерева оживает в лапатированном керамограните, чья зеркально-блестящая поверхность придает интерьерам роскошный и благородный вид. Яркий и оригинальный блеск лапатированного керамогранита под дерево сочетается благородной красотой удивительно реалистичной мраморной фактуры.





HARMONY AND CONTINUITY BETWEEN INTERIOR AND EXTERIOR DESIGN

Immergersi nel relax di avvolgenti atmosfere naturali

Etic PRO is available on a wide range of wood look porcelain tile finishes to meet the aesthetic and functional requirements of the design of indoor and outdoor spaces that have a bold and contemporary style. A comprehensive selection of surfaces inspired by original and exclusive types of wood, available in finishes for interior and exterior, that allows you to complete design freedom and with a pleasant stylistic and visual continuity that extends from indoors to outdoors.

Etic PRO offre un'ampia gamma di superfici in gres porcellanato effetto legno per rispondere alle esigenze estetiche e funzionali della progettazione di spazi interni ed esterni dallo stile attuale e deciso. Un progetto completo di superfici ispirate a originali ed esclusive essenze legno, disponibili in finiture per interni ed esterni, consente di progettare in libertà e con gradevole continuità stilistica e visiva spazi che dall'interno si estendono all'aria aperta.

STUNNING APPEAL

PROJECT: DESIGN RESIDENCE

AREA: INTERIOR&EXTERIOR

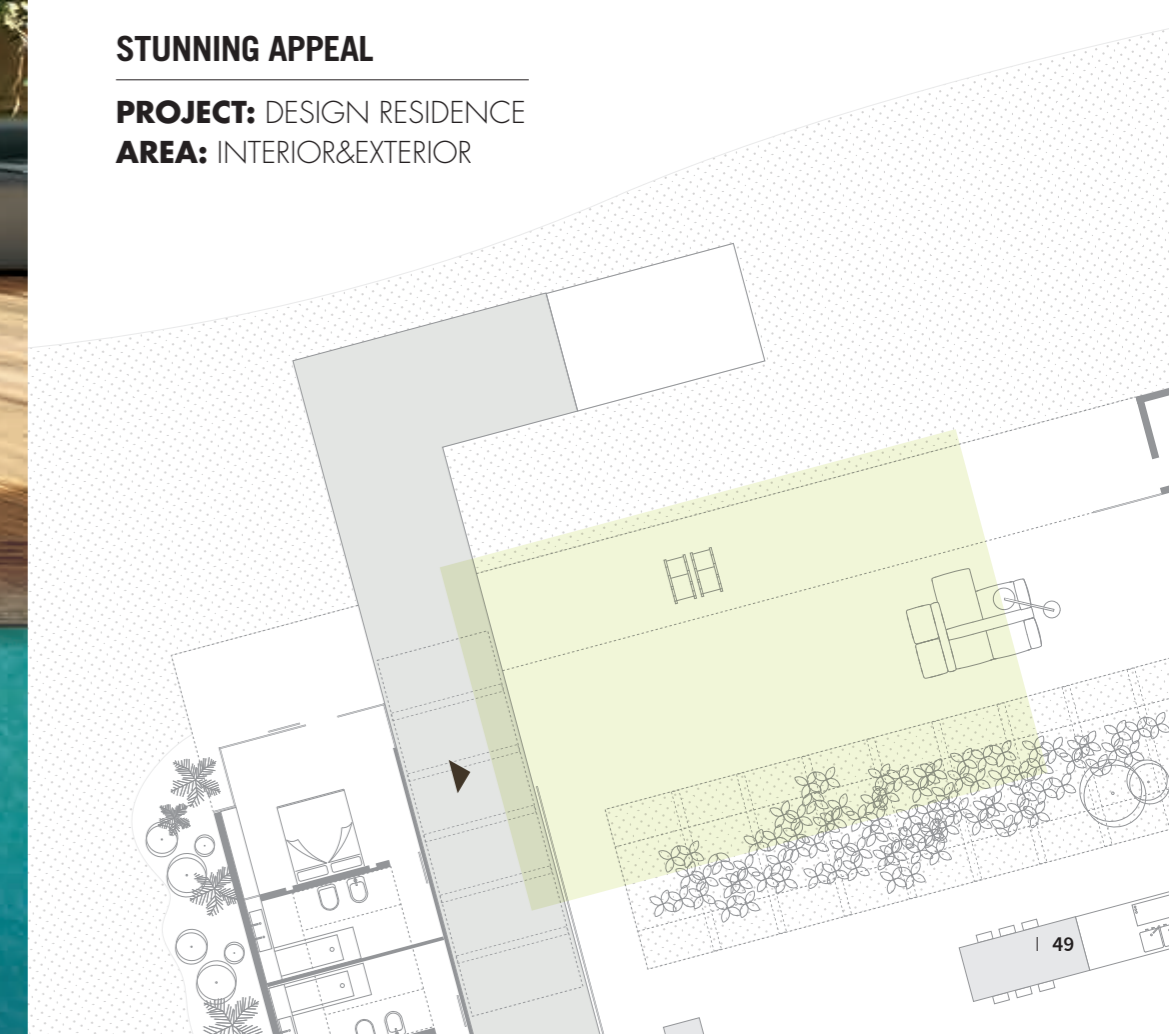

Etic Rovere Venice 25x150 cm
Etic Rovere Venice Grip 22,5x90 cm
Etic Rovere Venice Tatami 22,5x90 cm
Etic Rovere Venice Griglia 15 LASTRA 20mm 15x60 cm
Etic Rovere Venice Gradino Lineare SP LASTRA 20mm 30x60 cm



HARMONIE ET CONTINUITÉ ENTRE DES INTÉRIEURS ET EXTÉRIEURS DESIGN.

Etic PRO offre une vaste gamme de surfaces en grès cérame imitation bois pour répondre aux besoins esthétiques et fonctionnels de la conception d'espaces intérieurs et extérieurs de style actuel et incisif. Un projet complet de surfaces inspirées aux essences de bois, originales et exclusives, disponibles dans des finitions pour intérieurs et extérieurs, permet de concevoir en toute liberté et à travers une agréable continuité stylistique et visuelle des espaces qui depuis l'intérieur se déploient jusqu'à l'extérieur.

HARMONIE UND KONTINUITÄT ZWISCHEN INNEN- UND AUSSENBEREICHEN.

Etic PRO bietet ein breites Sortiment an Oberflächen aus Feinsteinzeug in Holz-Optik, um alle ästhetischen und funktionalen Anforderungen bei der Gestaltung von Innen- und Außenräumen in aktuellem und modernem Stil zu erfüllen. Ein vollständiges Projekt von Oberflächen inspiriert durch ursprüngliche und exklusive Holzarten, erhältlich in Ausführungen für den Innen- und Außenbereich, ermöglicht die freie Gestaltung in angenehmer stilistischer Kontinuität und Optik, um die Innenräume bis ins Freie visuell zu verlängern.

ARMONÍA Y CONTINUIDAD ENTRE INTERIORES Y EXTERIORES DE DISEÑO.

Etic PRO ofrece una amplia gama de superficies en gres porcelánico efecto madera para responder a las exigencias estéticas y funcionales de la proyectación de espacios interiores y exteriores de estilo actual y decidido. Un proyecto completo de superficies inspiradas en originales y exclusivas maderas, disponibles en acabados para interiores y exteriores, permite proyectar en plena libertad y con una agradable continuidad estilística y visual espacios que desde el interior se extienden hacia el aire libre.

ГАРМОНИЯ ВНУТРЕННИХ И НАРУЖНЫХ ПРОСТРАНСТВ.

Etic PRO предлагает богатую гамму керамогранитных плиток под дерево для красивого и функционального оформления внутренних и наружных пространств. Богатый набор плиток с фактурой эксклюзивных пород древесины доступен в различных вариантах поверхности – для интерьеров и для улицы. Это позволяет создавать цельные дизайнерские проекты, в которых наружные пространства являются естественным продолжением внутренних.



Etic Rovere Venice 25x150 cm, Etic Rovere Venice Tatami 22,5x90 cm

A WIDE RANGE OF TRIM TILES PERFECT FOR A MYRIAD OF OUTDOOR APPLICATIONS OR TO FINISH OFF SWIMMING POOL EDGES WITH STYLE.

Una vasta gamma di pezzi speciali è ideale per numerose applicazioni in esterno e per rifinire con stile bordi piscina.

Cette vaste gamme de pièces spéciales est idéale pour de multiples applications à l'extérieur et pour finir avec style les bords de piscine.

Die breite Palette von Formteilen ist ideal für viele Anwendungen im Außenbereich und zum stilvollen Abrunden von Poolumgebungen.

Una vasta gama de piezas especiales es ideal para múltiples aplicaciones en exteriores y para acabar con estilo los bordes de piscina.

Широкая гамма специальных элементов идеальна для уличного применения и стильного оформления краев бассейнов.

Etic Rovere Venice 25x150 cm, Etic Rovere Venice Tatami 22,5x90 cm
Etic Rovere Venice Griglia 15 LASTRA 20mm 15x60 cm
Etic Rovere Venice Gradino Lineare SP LASTRA 20mm 30x60 cm



Etic Rovere Venice LASTRA 20mm 30x120 cm



TATAMIDECOR

Thin listels soften the wood look for a minimalist and natural look for floors and walls.

Sottili listelli scompongono l'effetto legno per una decorazione minimalista e naturale di pavimenti e rivestimenti.

De fines lames décomposent l'imitation bois pour un décor minimaliste et naturel des sols et revêtements.

Dünne Leisten brechen den Holz-Effekt für ein minimalistisches Dekor der natürlichen Fußböden und Wandbeläge.

Finos listeles descomponen el efecto madera para una decoración minimalista y natural de pavimentos y revestimientos.

Тонкие плашки с фактурой дерева образуют натуральный минималистический декор полов и стен.

Etic Rovere Venice 25x150 cm, Etic Rovere Venice Tatami 22,5x90 cm | Etic Rovere Venice Herringbone 36,2x41,2 cm



ETIC PRO PORCELAIN TILES

25x150 cm - 97/8"x59" ± 9,5 mm

Etic Rovere Venice
25x150 cm / 97/8"x59"



Etic Noce Hickory
25x150 cm / 97/8"x59"



COLOURED BODY PORCELAIN TILES - RECTIFIED MONOCALIBER GRES PORCELLANATO COLORATO IN MASSA - RETTIFICATO MONOCALIBRO

Grès cérame coloré dans la masse - Rectifié mono-calibre / Durchgefärbtes Feinsteinzeug - Geschliffen einkalibrig
Gres porcelánico coloreado en masa - Rectificado monocolor / Керамический гранит окрашенный в массе - Ретифицированный в одном калибре



Etic Quercia Antique
25x150 cm / 97/8"x59"



Etic Eucalipto Smoked
25x150 cm / 97/8"x59"



INSTALLATION TIPS / SUGGERIMENTI DI POSA

In straight-forward installation patterns, it is recommended a maximum staggering of listels of 50 cm and a grout line of 1-2 mm in indoor applications. Jointless installation is not recommended. / In posa a correre, si consiglia la sfalsatura dei listoni di massimo 50 cm e fuga di 1-2 mm in interno. È fortemente sconsigliata la posa a giunto unito. / Pour la pose à l'anglaise, nous conseillons un décalage des lames de 50 cm au maximum et un joint de 1 à 2 mm à l'intérieur. Il est absolument déconseillé de réaliser la pose avec joint nul.

25x150 cm

Bei fortlaufender Verlegung ist es empfehlenswert die Platten maximal 50 cm versetzt und mit einer Fuge von 1-2 mm in Innenbereichen zu verlegen. Von einer fugenlosen Verlegung wird dringend abgeraten. / En colocación simple, se aconseja escalonar los listones por un máximo de 50 cm y una junta de 1-2 mm para interiores. Se desaconseja vivamente la colocación sin juntas. / При укладке вразбежку рекомендуется укладывать плитки со смещением не более 50 см и со швом 1-2 мм внутри помещений. Настоятельно не рекомендуется укладывать плитки без швов.

ETIC PRO PORCELAIN TILES

22,5x90 cm - 8⁷/₈"x35³/₈" | 15x90 cm - 5⁷/₈"x35³/₈" ± 9 mm



Etic Rovere Venice

22,5x90 cm / 8⁷/₈"x35³/₈"



Etic Noce Hickory

22,5x90 cm / 8⁷/₈"x35³/₈"



Etic Quercia Antique

22,5x90 cm / 8⁷/₈"x35³/₈"



Etic Eucalipto Smoked

22,5x90 cm / 8⁷/₈"x35³/₈"



Etic Rovere Venice

15x90 cm / 5⁷/₈"x35³/₈"



Etic Noce Hickory

15x90 cm / 5⁷/₈"x35³/₈"



Etic Quercia Antique

15x90 cm / 5⁷/₈"x35³/₈"



Etic Eucalipto Smoked

15x90 cm / 5⁷/₈"x35³/₈"



POLISHED SURFACES

22,5x90 cm - 8⁷/₈"x35³/₈" ± 9 mm



Etic Rovere Venice Lappato

22,5x90 cm / 8⁷/₈"x35³/₈"



Etic Noce Hickory Lappato

22,5x90 cm / 8⁷/₈"x35³/₈"



Etic Quercia Antique Lappato

22,5x90 cm / 8⁷/₈"x35³/₈"



Etic Eucalipto Smoked Lappato

22,5x90 cm / 8⁷/₈"x35³/₈"

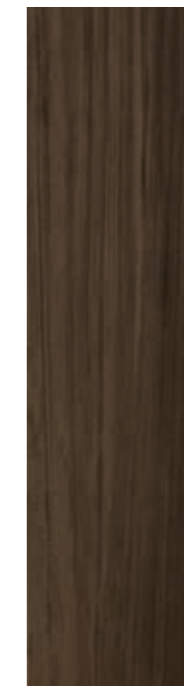

INSTALLATION TIPS SUGGERIMENTI DI POSA

22,5x90 cm - 15x90 cm

In straight-forward installation patterns, it is recommended a maximum staggering of listels of 35 cm and a grout line of 1-2 mm in indoor applications and of 3 mm in outdoor applications. Joint-less installation is not recommended. / In posa a correre, si consiglia la sfalsatura dei listoni di massimo 35 cm e fuga di 1-2 mm in interno, 3 mm in esterno. È fortemente sconsigliata la posa a giunto unito. / Pour la pose à l'anglaise, nous conseillons un décalage des lames de 35 cm au maximum et un joint de 1 à 2 mm à l'intérieur, et de 3 mm à l'extérieur. Il est absolument déconseillé de réaliser la pose avec joint nul. / Bei fortlaufender Verlegung ist es empfehlenswert die Platten maximal 35 cm versetzt und mit einer Fuge von 1-2 mm in Innenbereichen bzw. 3 mm in Außenbereichen zu verlegen. Von einer fugenlosen Verlegung wird dringend abgeraten. / En colocación simple, se aconseja escalonar los listones por un máximo de 35 cm y una junta de 1-2 mm para interiores, 3 mm para exteriores. Se desaconseja vivamente la colocación sin juntas. / При укладке вразбежку рекомендуется укладывать плитки со смещением не более 35 см и со швом 1-2 мм внутри помещений, 3 мм на улице. Настоятельно не рекомендуется укладывать плитки без швов.

ETIC PRO PORCELAIN TILES OUTDOOR PAVING ± 20 mm

30x120 cm - 11³/₄"x47¹/₄" | 60x60 cm - 23⁵/₈"x23⁵/₈" ± 20 mm



Etic Rovere Venice LASTRA 20mm
30x120 cm / 11³/₄"x47¹/₄"



Etic Noce Hickory LASTRA 20mm
30x120 cm / 11³/₄"x47¹/₄"



Etic Quercia Antique LASTRA 20mm
30x120 cm / 11³/₄"x47¹/₄"



Etic Eucalipto Smoked LASTRA 20mm
30x120 cm / 11³/₄"x47¹/₄"



Etic Rovere Venice LASTRA 20mm
60x60 cm / 23³/₈"x23³/₈"



LASTRA 20E

For further details on the 20 mm product, relevant trims and the installation systems, in particular for recommendations, restrictions of use, and precautions during installation, please refer to the LASTRA 20mm section on the Atlas Concorde website or to the LASTRA 20mm catalogue. Per dettagli sul prodotto e sui relativi pezzi speciali in 20 mm di spessore, per i sistemi di posa e, in particolare, per raccomandazioni, accorgimenti, limitazioni di utilizzo e precauzioni in fase di posa, si raccomanda di prendere visione del catalogo LASTRA 20mm e della sezione LASTRA 20mm del sito Atlas Concorde.

PORCELAIN TILES GRIP SURFACES

22,5x90 cm - 8⁷/₈"x35³/₈" ± 9 mm



Etic Rovere Venice Grip
22,5x90 cm / 8⁷/₈"x35³/₈"



Etic Noce Hickory Grip
22,5x90 cm / 8⁷/₈"x35³/₈"



Etic Quercia Antique Grip
22,5x90 cm / 8⁷/₈"x35³/₈"



Etic Eucalipto Smoked Grip
22,5x90 cm / 8⁷/₈"x35³/₈"

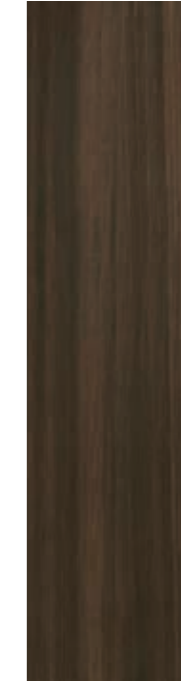

ETIC PRO PORCELAIN TILES DECORS

Etic Rovere Venice Industrial 3D
44x28,5 cm / 17³/₈"x11¹/₄"



Etic Noce Hickory Industrial 3D
44x28,5 cm / 17³/₈"x11¹/₄"



Etic Quercia Antique Industrial 3D
44x28,5 cm / 17³/₈"x11¹/₄"



Etic Eucalipto Smoked Industrial 3D
44x28,5 cm / 17³/₈"x11¹/₄"

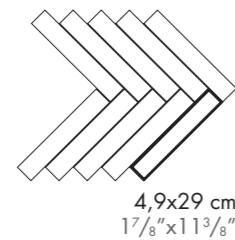
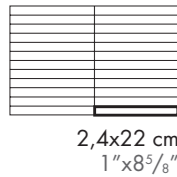

Etic Rovere Venice Herringbone
36,2x41,2 cm / 14¹/₈"x16¹/₈"



Etic Noce Hickory Herringbone
36,2x41,2 cm / 14¹/₈"x16¹/₈"



Etic Quercia Antique Herringbone
36,2x41,2 cm / 14¹/₈"x16¹/₈"



Etic Eucalipto Smoked Herringbone
36,2x41,2 cm / 14¹/₈"x16¹/₈"



Etic Rovere Venice Chevron A+B
35x34,5 cm cm / 13³/₄"x13⁵/₈"



Etic Noce Hickory Chevron A+B
35x34,5 cm cm / 13³/₄"x13⁵/₈"



Etic Quercia Antique Chevron A+B
35x34,5 cm cm / 13³/₄"x13⁵/₈"



Etic Eucalipto Smoked Chevron A+B
35x34,5 cm cm / 13³/₄"x13⁵/₈"

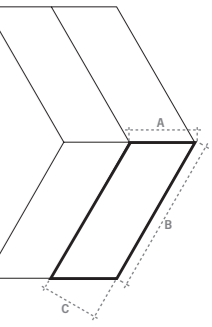

A 17 cm - 6³/₄"
B 39,8 cm - 15⁵/₈"
C 14,7 cm - 5³/₄"



ETIC PRO PORCELAIN TILES DECORS

Etic Rovere Venice
Chevron Tatami A+B
74x22,2 cm / 29¹/₈"x8⁵/₈"

Etic Noce Hickory
Chevron Tatami A+BD
74x22,2 cm / 29¹/₈"x8⁵/₈"

Etic Quercia Antique
Chevron Tatami A+B
74x22,2 cm / 29¹/₈"x8⁵/₈"

Etic Eucalipto Smoked
Chevron Tatami A+B
74x22,2 cm / 29¹/₈"x8⁵/₈"



Etic Rovere Venice Tatami
22,5x90 cm / 8⁷/₈"x35³/₈"

Etic Noce Hickory Tatami
22,5x90 cm / 8⁷/₈"x35³/₈"

Etic Quercia Antique Tatami
22,5x90 cm / 8⁷/₈"x35³/₈"

Etic Eucalipto Smoked Tatami
22,5x90 cm / 8⁷/₈"x35³/₈"



2,3x90 cm
7/8"x35³/₈"

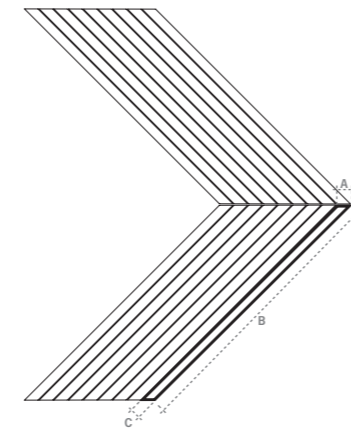

A 3,2 cm - 1¹/₄"
B 73,8 cm - 29"
C 2,3 cm - 7/8"



THANKS TO SI RINGRAZIANO

il fuoco degli Dei®
www.ilfuocodegliidei.com

LIVING
DIVANI
www.livingdivani.it

BELTRAMI EMORE
LAVORAZIONE PELLE PRECATA
www.beltramipelleteria.it

AXO
LIGHT
www.axolight.it

bongio
www.bongio.it

ETIC PRO LAYING TIPS & COLOUR SHADING

FOR AN INSTALLATION ABLE TO EXALT THE GRAPHIC VERSATILITY AND COLOUR SHADING OF THE ETIC COLLECTION, WE RECOMMEND THE FOLLOWING:

■ Staggering of slabs: maximum 1/3 of the length (both for the 150 cm and the 90 cm size).

■ Mixing of slabs: before proceeding with installation, it is recommended to open the boxes, place the tiles onto a flat surface to assess their graphics and choose slabs from different boxes with different colour shading.

PER UNA POSA IN GRADO DI VALORIZZARE LA VARIETÀ GRAFICA E LA STONALIZZAZIONE DELLA COLLEZIONE ETIC PRO SI SUGGERISCE DI SEGUIRE I SEGUENTI ACCORGIMENTI:

■ Sfalsamento listoni: massimo 1/3 della lunghezza (sia per il formato 150 che per il formato 90 cm).

■ Miscelazione listoni: prima di procedere alla posa dei listoni, si consiglia di aprire le scatole, stendere il prodotto per valutare la varietà grafica, e posare i listoni scegliendo pezzi provenienti da scatole differenti e con differenti grafiche e variazioni cromatiche.

POUR OBTENIR UNE POSE QUI VALORISE LA VARIÉTÉ GRAPHIQUE ET L'EFFET DENUANCE DE LA COLLECTION ETIC PRO, NOUS CONSEILLONS DE SUIVRE LES INDICATIONS SUIVANTES :

■ Lames en décalé : maximum 1/3 de la longueur (aussi bien au format 150 cm que 90 cm).

■ Lames mélangées : avant de procéder à la pose des lames, nous conseillons d'ouvrir les boîtes, d'étaler le produit pour évaluer la variété graphique, et de poser les lames en choisissant des pièces provenant de différentes boîtes et avec divers graphiques et variations chromatiques.

FÜR EINE VERLEGUNG, DIE DEN GRAPHISCHEN ABWECHSLUNGSREICHUM UND DIE ABSTUFUNGEN DER KOLLEKTION ETIC PRO BETONT, SCHLAGEN WIR VOR, DIE FOLGENDEN SCHRITTE AUSZUFÜHREN:

■ Versetzte Planken: maximal 1/3 der Länge (sowohl für das Format 150 als auch für das Format 90 cm).

■ Gemischte Planken: Vor dem Verlegen der Planken empfehlen wir Ihnen die Kartons zu öffnen, das Produkt auszulegen, um den graphischen Abwechslungsreichtum zu beurteilen und dann erst die Planken, die Sie aus verschiedenen Kartons mit unterschiedlichen Grafiken und Farbvariationen nehmen, zu verlegen.

PARA UNA COLOCACIÓN CAPAZ DE VALORIZAR LA VARIEDAD GRÁFICA Y DE TONO DE LA COLECCIÓN ETIC PRO SE SUGIERE CONSIDERAR LAS SIGUIENTES PRECAUCIONES:

■ Escalonamiento de los listones: máximo 1/3 del largo (tanto para el formato 150 como para el formato 90 cm).

■ Mezcla de los listones: antes de proceder con la colocación de los listones, se aconseja abrir las cajas, extender el producto para evaluar la variedad gráfica, y colocar los listones escogiendo piezas provenientes de cajas diferentes y con diferentes aspectos gráficos y variaciones cromáticas.

ЧТОБЫ ПОДЧЕРКНУТЬ БОГАТСТВО РИСУНКА И ЦВЕТОВ КОЛЛЕКЦИИ ETIC PRO, РЕКОМЕНДУЕМ СЛЕДОВАТЬ СЛЕДУЮЩИМ УКАЗАНИЯМ ПО УКЛАДКЕ:

■ Смещение плиток: не более 1/3 длины (как для формата 150, так и для формата 90 см).

■ Перемешивание плиток: перед укладкой рекомендуем открыть коробки, разложить плитки и внимательно рассмотреть их поверхность, после чего приступить к укладке, беря разные по рисунку и цвету плитки из разных коробок.

FOR A STATE-OF-THE-ART INSTALLATION, IT IS RECOMMENDED TO: / PER UNA POSA OTTIMALE SI SUGGERISCE DI:

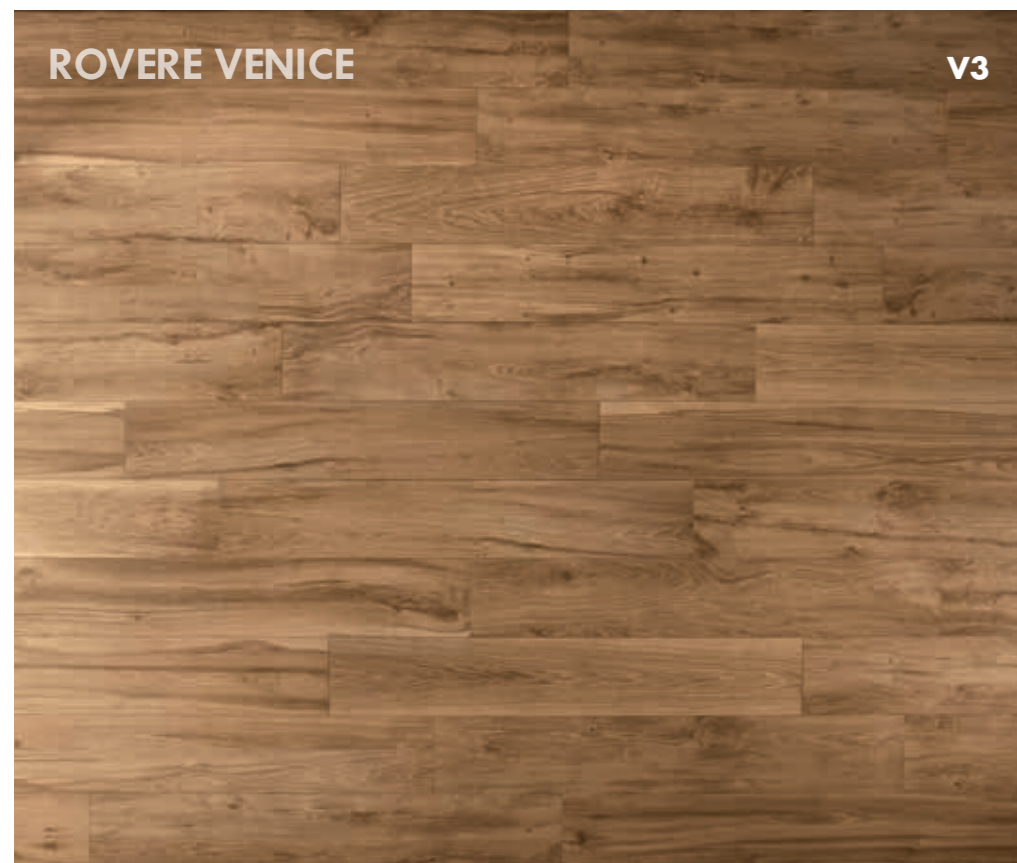

1. Open the boxes and assess the graphics of the tiles.
2. Mix the slabs combining different types of graphics: slabs with knots, sapwood, directional veining.
Avoid installation adjacent to tiles with a similar graphics in order to give a sense of motion to the surface and increase the colour shading effect.

1. Aprire diverse scatole e valutare la varietà grafica.
2. Miscelare i listoni e affiancare tipologie grafiche differenti: listoni con nodi, listoni con alburni, listoni con venature direzionate.
Evitare di avvicinare listoni similari permetterà di dare ricchezza e movimento al pavimento, incrementandone la stonalizzazione.

1. Ouvrir différentes boîtes et évaluer la variété graphique.
2. Mélanger les lames et juxtaposer des types de graphiques différents : lames avec nœuds, lames avec alburniers, lames avec veines directionnelles.
Éviter de rapprocher des lames semblables permettra de donner de la richesse et du mouvement au sol, en accentuant l'effet dénuancé.

1. Öffnen Sie mehrere Kartons und bewerten Sie den graphischen Abwechslungsreichtum.
2. Mischen Sie die Planken und kombinieren verschiedene Arten von Grafiken: Planken mit Knoten, Planken mit Splintholz, Planken mit Aderungen.
Vermeiden Sie ähnliche Planken nebeneinander, um auf dem Boden Dynamik und Bewegung zu schaffen und um die Abstufungen zu erhöhen.

1. Abrir cajas diferentes y evaluar la variabilidad gráfica.
2. Mezclar los listones y poner juntos tipos gráficos diferentes: listones con nudos, listones con alburnos, listones con vetas orientadas.
Evitar acercar listones similares permitirá dar riqueza y una sensación de movimiento al pavimento, incrementando su variación tonal.

1. Открыть несколько коробок и внимательно рассмотреть поверхность плиток.
2. Перемешать плитки и расположить рядом плитки с разным рисунком: с сучками, заболонью, прожилками.
Старайтесь не располагать рядом одинаковые плитки: это позволит получить богатое и натуральное по виду напольное покрытие.

FOR A STATE-OF-THE-ART INSTALLATION, IT IS RECOMMENDED TO: / PER UNA POSA OTTIMALE SI SUGGERISCE DI:



1. Open the boxes and assess the graphics of the tiles.
2. Mix bi-colour slabs with dark slabs. The recommended proportion is 1 dark slab every 3/4 bi-colour slabs.
3. Taking the short side of the slabs as a reference (25, 22,5 or 15 cm), alternate bright and dark stripes, avoiding that the bright (or dark) band continues the band of the same colour.

1. Aprire diverse scatole e valutare la varietà grafica.
2. Miscelare i listoni bicolore con i listoni interamente scuri. La proporzione consigliata è 1 listone scuro ogni 3/4 listoni bicolore.
3. Prendendo a riferimento il lato corto dei listoni (25, 22,5 o 15 cm) alternare striature chiare a striature scure, evitando che la fascia chiara (o scura) di un listone continui la fascia dello stesso colore.

1. Open the boxes and assess the graphics of the tiles: the Eucalyptus colour is more uniform than the others and has a lighter shading that make the slabs appear to have a more homogeneous aspect.
2. Mix the slabs trying to install adjacent tiles of different types in order to create a "shaded effect" (dark-bright-dark) avoiding strong chromatic contrasts.

1. Aprire diverse scatole e valutare la varietà grafica: il colore Eucalipto è più uniforme rispetto agli altri e presenta passaggi di colore più gradualmente, che rendono i listoni in apparenza più omogenei.
2. Miscelare i listoni cercando di affiancare tipologie differenti per creare "sfumature" (scuro-chiaro-scuro) evitando salti troppo netti di cromatiche.

1. Ouvrir différentes boîtes et évaluer la variété graphique.
2. Mélanger les lames bicolores et les lames entièrement foncées. La proportion conseillée est 1 lame foncée toutes les 3 ou 4 lames bicolores.
3. En se référant au côté court des lames (25, 22,5 ou 15 cm), alterner les stries claires et les stries foncées, en évitant que la bande claire (ou foncée) d'une lame se trouve à côté d'une bande de même couleur.

1. Ouvrir différentes boîtes et évaluer la variété graphique : la couleur Eucalyptus plus uniforme par rapport aux autres présente des passages de couleur plus graduels, qui rendent les lames apparemment plus homogènes.
2. Mélanger les lames en essayant de juxtaposer différents types pour créer des "nuances" (clair-foncé-clair) en évitant les écarts chromatiques trop nets.

1. Öffnen Sie mehrere Kartons und bewerten Sie den graphischen Abwechslungsreichtum: die Farbe Eucalypto ist gleichmäßiger als die anderen und hat weichere Farbübergänge, die die Planken scheinbar homogener werden lassen.
2. Mischen Sie die Planken und versuchen Sie, verschiedene Arten zu kombinieren, um "Abstufungen" (Dunkel-Hell-Dunkel) zu schaffen, dabei sollten jedoch harte Farbsprünge vermieden werden.

1. Abrir cajas diferentes y evaluar la variabilidad gráfica.
2. Mezclar los listones bicolor con los listones totalmente oscuros.
La proporción aconsejada es de 1 listón oscuro por cada 3/4 listones bicolores.
3. Tomando como referencia el lado corto de los listones (25, 22,5 ó 15 cm) alternar estrías claras y estrías oscuras, evitando que la franja clara (o oscura) de un listón continúe la franja del mismo color.

1. Abrir cajas diferentes y evaluar la variabilidad gráfica: el color Eucalipto es más uniforme respecto de los otros y presenta cambios de color más graduales, que dan una apariencia más homogénea a los listones.
2. Mezclar los listones tratando de acercar tipos diferentes para crear "matices" (oscuro-claro-oscuro) evitando saltos demasiado netos de las tonalidades.

1. Открыть несколько коробок и внимательно рассмотреть поверхность плиток: тон Eucalypto несколько однороднее других и имеет более плавные цветовые переходы, поэтому плитки кажутся однороднее.
2. Перемешать плитки, стараясь располагать рядом разные по виду поверхности для получения разнообразных светлых и темных оттенков. Вместе с тем не допускайте слишком резких цветовых перепадов.



Uniform appearance
Variazione minima
Aspect uniforme
Gleichmäßiges Erscheinungsbild
Aspecto uniforme
Однородный вид



Slight variation
Variazione moderata
Variation minimale
Leichte Abweichung
Variación mínima
Минимальная Неоднородность



Moderate variation
Variazione moderata
Variation Modérée
Mäßige Abweichung
Variación moderada
Умеренная Неоднородность

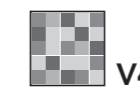

Substantial variation
Variazione sostanziale
Variation substantielle
Grundlegende Abweichung
Variación sustancial
Значительная Неоднородность

ETIC PORCELAIN TILES

COLOURED BODY PORCELAIN TILES - RECTIFIED MONOCALIBER

GRES PORCELLANATO COLORATO IN MASSA - RETTIFICATO MONOCALIBRO

Grès cérame coloré dans la masse - Rectifié mono-calibre / Durchgefärbtes Feinsteinzeug - Geschliffen einkalibrig

Gres porcelánico coloreado en masa - Rectificado monocalibre / Керамический гранит окрашенный в массе - Ретифицированный в одном калибре

SIZES AND SURFACES / FORMATI E SUPERFICI

MATTE / MATT

MAT / MATT / MATE / МАТОВАЯ



25x150 cm - 9 ⁷ / ₈ "x59"	± 9,5 mm ■
22,5x90 cm - 8 ⁷ / ₈ "x35 ³ / ₈ "	± 9 mm ●
15x90 cm - 7 ⁷ / ₈ "x35 ³ / ₈ "	± 9 mm ●
11x90 cm - 4 ³ / ₈ "x35 ³ / ₈ "	± 9 mm ●

TEXTURED / STRUTTURATA

STRUCTURÉ / STRUKTURIERT / ESTRUCTURADO / СТРУКТУРНАЯ



22,5x90 cm - 8 ⁷ / ₈ "x35 ³ / ₈ "	± 9 mm ●
---	----------

- Available in all colors / Disponibile in tutti i colori
- Available in the following colors / Disponibile nei seguenti colori
Rovere, Noce, Rovere Bianco, Rovere Grigio, Palissandro

COLOR-SHADING STONALIZZAZIONE

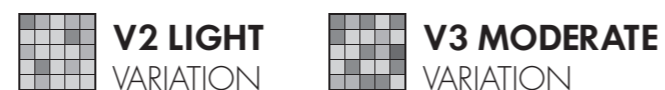

ETIC PORCELAIN TILES DECORS

Etic Rovere
Tatami 22,5x90
22,5x90 cm / 8⁷/₈"x35³/₈"



Etic Ulivo
Tatami 22,5x90
22,5x90 cm / 8⁷/₈"x35³/₈"



Etic Noce
Tatami 22,5x90
22,5x90 cm / 8⁷/₈"x35³/₈"



Etic Palissandro
Tatami 22,5x90
22,5x90 cm / 8⁷/₈"x35³/₈"

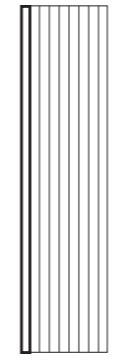

2,3x90 cm
1⁷/₈"x35³/₈"

Etic Rovere Bianco
Tatami 22,5x90
22,5x90 cm / 8⁷/₈"x35³/₈"



Etic Rovere Grigio
Tatami 22,5x90
22,5x90 cm / 8⁷/₈"x35³/₈"



Etic Ebano
Tatami 22,5x90
22,5x90 cm / 8⁷/₈"x35³/₈"



Etic Rovere
Cassettone 45
45x45 cm / 17³/₄"x17³/₄"



Etic Ulivo
Cassettone 45
45x45 cm / 17³/₄"x17³/₄"



Etic Noce
Cassettone 45
45x45 cm / 17³/₄"x17³/₄"



Etic Palissandro
Cassettone 45
45x45 cm / 17³/₄"x17³/₄"

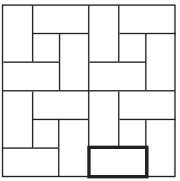

14,5x7,4 cm
5³/₄"x2⁷/₈"

Etic Rovere Bianco
Cassettone 45
45x45 cm / 17³/₄"x17³/₄"



Etic Rovere Grigio
Cassettone 45
45x45 cm / 17³/₄"x17³/₄"



Etic Ebano
Cassettone 45
45x45 cm / 17³/₄"x17³/₄"



Etic Rovere
Bottone 7x7
7x7 cm / 2³/₄"x2³/₄"



Etic Ulivo
Bottone 7x7
7x7 cm / 2³/₄"x2³/₄"



Etic Noce
Bottone 7x7
7x7 cm / 2³/₄"x2³/₄"



Etic Palissandro
Bottone 7x7
7x7 cm / 2³/₄"x2³/₄"



Etic Rovere Bianco
Bottone 7x7
7x7 cm / 2³/₄"x2³/₄"



Etic Rovere Grigio
Bottone 7x7
7x7 cm / 2³/₄"x2³/₄"



Etic Ebano
Bottone 7x7
7x7 cm / 2³/₄"x2³/₄"



ETIC PRO PORCELAIN TRIM TILES

INDOOR TRIM TILES

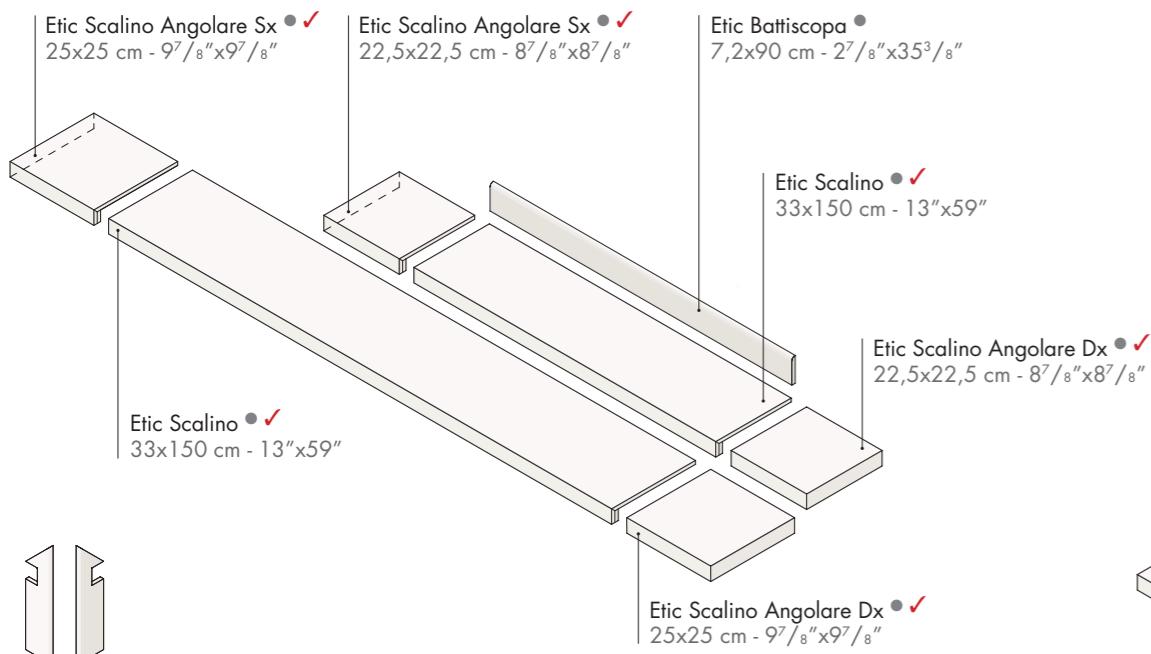

Etic Battiscopa Sagomato Sx/Dx ● ✓
7,2x30 cm - 2⁷/₈"x11³/₄"

● Available in all colors / Disponibile in tutti i colori
✓ These parts are supplied to order / I pezzi sono disponibili su ordinazione

OUTDOOR TRIM TILES ± 20 mm

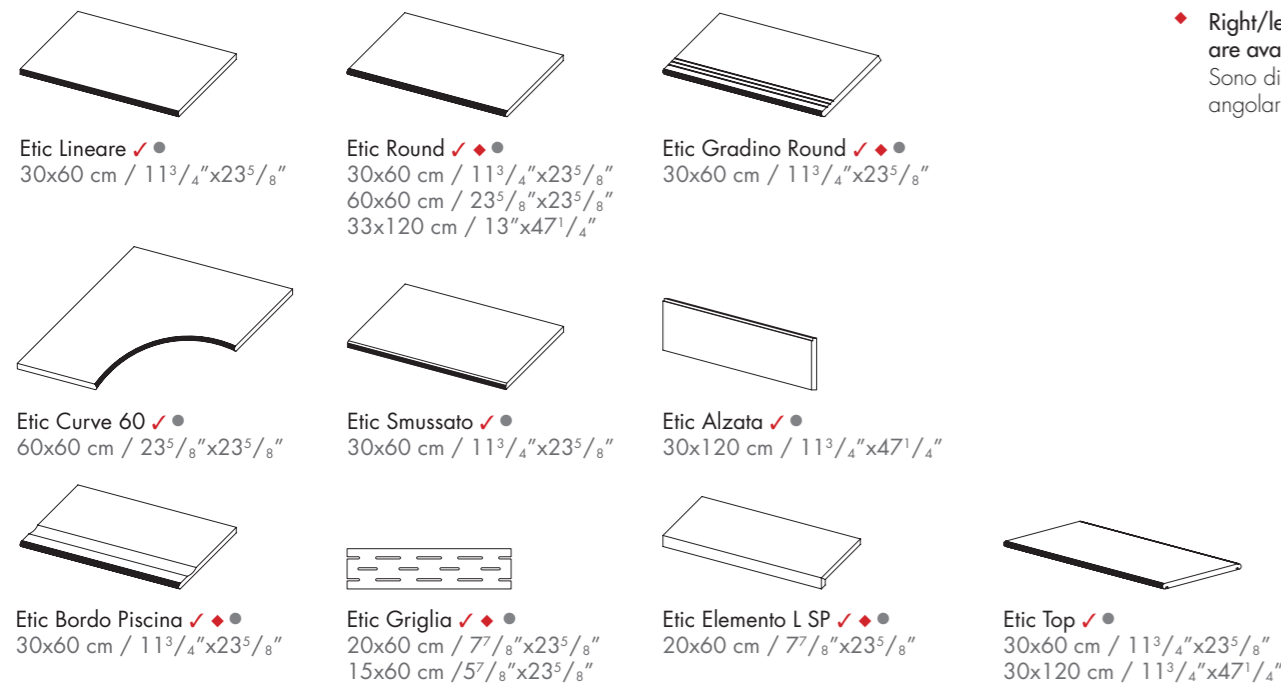

◆ Right/left angular elements are available
Sono disponibili gli elementi angolari dx/sx

OUTDOOR TRIM TILES

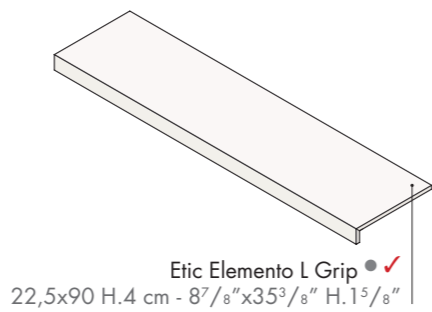

NOTES / NOTE

For information and details relating to codes, packaging and weight it is recommended to refer to the latest price list. Per le informazioni e i dati relativi a codici, imballaggi e pesi occorre sempre consultare l'ultimo listino aggiornato e in vigore.

Pour toutes informations et renseignements concernant les codes, les emballages et les poids, il y a toujours lieu de consulter le dernier tarif en vigueur et mis à jour. Für Informationen und Daten die den Code, die Verpackung und das Gewicht betreffen bitte die aktuellste Preisliste zugrunde legen. Para acceder a la información y a los datos relativos a códigos, embalajes y pesos hay que consultar siempre la última lista de precios actualizada y vigente. Для информации о кодах, упаковках и весе обращайтесь к последнему действующему прайс-листу.

Colors and optical features of the materials illustrated in this catalogue are to be regarded as mere indications. I colori e le caratteristiche estetiche dei materiali illustrati nel presente catalogo sono da ritenersi puramente indicativi.

Les coloris et les caractéristiques esthétiques des références illustrées dans le catalogue sont donnés à titre purement indicatif. Die Farben und die ästhetischen Eigenschaften der in diesem Katalog abgebildeten Produkte sind als reine Richtwerte zu betrachten. Los colores y las características estéticas de los materiales ilustrados en el presente catálogo deben ser considerados como puramente indicativos. Цвета и эстетические характеристики описанных в настоящем каталоге материалов являются только ориентировочными.

Atlas Concorde reserves the right to modify any product without notice and will not be liable for any direct or indirect damage resulting from such modifications. Atlas Concorde si riserva di modificare i prodotti senza preavviso, declinando ogni responsabilità su eventuali danni diretti o indiretti derivanti da eventuali modifiche.

Atlas Concorde se réserve le droit de modifier ses produits sans préavis et décline toute responsabilité concernant les éventuels dommages directs ou indirects qui pourraient dériver de ces modifications. Atlas Concorde behält sich das Recht vor jederzeit und ohne vorherige Ankündigung, die Produkte zu verändern, und lehnt jede Haftung bei direkten oder indirekten Schäden ab, die von diesen Veränderungen herrühren. Atlas Concorde se reserva el derecho de modificar los productos sin previo aviso, rechaza cualquier responsabilidad sobre eventuales daños directos o indirectos derivados de eventuales modificaciones. Atlas Concorde оставляет за собой право изменять характеристики изделий без предварительного уведомления, отклоняя при этом любую ответственность за прямые или косвенные убытки, возникшие в результате изменений.

Coloured body porcelain tiles - Rectified monocaliber

Gres porcellanato colorato in massa - Rettificato monocalibro



Compliant with standards EN 14411 annex G group B
Compliant with standards ISO 13006 annex G group B
Conforme alla norma EN 14411 Appendice G gruppo B
Conforme alla norma ISO 13006 Appendice G gruppo B

25x150 cm - 9⁷/₈"x59"
22,5x90 cm - 8⁷/₈"x35³/₈"
15x90 cm - 5⁷/₈"x35³/₈"

± 9,5 mm
± 9 mm
± 9 mm

30x120 cm - 11³/₄"x47¹/₄"
60x60 cm - 23⁵/₈"x23⁵/₈"

± 20 mm
± 20 mm

Technical features Caratteristiche tecniche	Test Method Metodo di prova	Requirements for nominal size N / Requisiti per dimensione nominale N			
		7 cm ≤ N < 15 cm (mm)	N ≥ 15 cm (%) (mm)		
Regularity Caratteristiche di Regolarità	Length and width Lunghezza e larghezza	± 0,9 ^(*)	± 0,6 ^(*)	± 2,0 ^(*)	
		Thickness Spessore	± 0,5 ^(**)	± 0,5 ^(**)	± 0,5 ^(**)
		Straightness of sides Rettilineità degli spigoli	± 0,75 ^(***)	± 0,5 ^(***)	± 1,5 ^(***)
	Rectangularity (Measurement only on short edges when L/l ≥ 3) Ortogonalità (Misurazione da condurre solo sui lati corti quando L/l ≥ 3)	± 0,75 ^(****)	± 0,5 ^(****)	± 2,0 ^(****)	
Surface flatness Planarità	ISO 10545-2	c.c. ± 0,75	c.c. ± 0,5	c.c. ± 2,0	
		e.c. ± 0,75	e.c. ± 0,5	e.c. ± 2,0	
		w. ± 0,75	w. ± 0,5	w. ± 2,0	

Structural Characteristics Caratteristiche Strutturali	Water absorption (in% by mass) Massa d'acqua assorbita (come % della massa)	ISO 10545-3	EN 14411 annex G (Group B)	ISO 13006 annex G (Group B)
			EN 14411 appendice G (Gruppo B)	ISO 13006 appendice G (Gruppo B)
			E _v ≤ 0,5% Individual Maximum 0,6%	E _v ≤ 0,5% Valore massimo singolo 0,6%
			Requirement ANSI A 137.1 Water absorption max ≤ 0,5%	

Bulk Mechanical Characteristics Caratteristiche Meccaniche Massive	Breaking strength Sforzo di rottura	ISO 10545-4	S ≥ 1300 N	
			R ≥ 35 N/mm ²	
	Modulus of rupture Resistenza alla flessione	EN 1339 Annex F	-	
	Bending strength and breaking load (3)(4) Resistenza a flessione e al carico di rottura		-	
	Impact resistance, as coefficient of restitution Resistenza all'impatto, espresso come coefficiente di restituzione	ISO 10545-5	Declared value Dichiarare un valore	Test method available Metodo di prova disponibile

Surface mechanical Characteristics Caratteristiche meccaniche superficiali	Mohs hardness Durezza Mohs	EN 101	-	
			Resistance to deep abrasion of unglazed tiles (removed volume) Resistenza all'abrasione profonda delle piastrelle non smaltate (volume materiale asportato)	ISO 10545-6

Thermal and Igmometric Characteristics Caratteristiche Termo-Igrometriche	Coefficient of thermal expansion Coefficiente di dilatazione termica lineare	ISO 10545-8	Declared value Dichiarare un valore	Test method available Metodo di prova disponibile		
			Thermal shock resistance Resistenza agli sbalzi termici	ISO 10545-9	Pass according to EN ISO 10545-1 Test superato in accordo con ISO 10545-1	Test method available Metodo di prova disponibile
					Moisture expansion (in mm/m) Dilatazione all'umidità (in mm/m)	ISO 10545-10
			Frost resistance Resistenza al gelo	ISO 10545-12		

Physical Properties Proprietà fisiche	Bond strength/adhesion for improved cementitious adhesives Adesione a trazione con adesivi cementizi migliorati	EN 1348	Declared value Dichiarare un valore	-
			Reaction to fire Reazione al fuoco	-

Chemical Characteristics Caratteristiche Chimiche	Resistance to household chemicals and swimming pool salts Resistenza ai prodotti chimici di uso domestico e agli additivi per piscina	ISO 10545-13	Minimum Class B (UB for unglazed tiles) Classe minima B (UB per piastrelle non smaltate)			
			Resistance to low concentrations of acids and alkalis Resistenza a basse concentrazioni di acidi e alcali	ISO 10545-13	Declared Class Dichiarare una Classe	Manufacturer is to state classification Secondo la classificazione indicata dal fabbricante
					Resistance to high concentrations of acids and alkalis Resistenza ad alte concentrazioni di acidi e alcali	ISO 10545-13
Resistance to staining Resistenza alle macchie	ISO 10545-14	Declared Class Dichiarare una Classe	Test method available Metodo di prova disponibile			

Safety Characteristics Caratteristiche di sicurezza (1)(2)	Barefoot Ramp Test Metodo della rampa a piedi nudi	DIN 51097 (CEN/TS 16165, Annex A)	Declared value Dichiarare un valore	-		
			Shod Ramp Test Metodo della rampa "calzata"	DIN 51130 (CEN/TS 16165, Annex B)	Declared value Dichiarare un valore	-
					Pendulum Friction Test Metodo del Pendolo	UNE-ENV 12633 (CEN/TS 16165, Annex C)

Safety Characteristics Caratteristiche di sicurezza (1)(2)	Coefficient of friction (COF) Coefficiente di attrito	B.C.R.A. Rep. CEC/81	D. M. 236/89 del 14/06/89			
			μ > 0,40 per elemento scivolante cuoio su pavimentazione asciutta			
			μ > 0,40 per elemento scivolante gomma dura su pavimentazione bagnata			
			ANSI A.137.1 Requires a minimum value of 0.42 for commercial areas that are likely to be wet.			
	Dynamic coefficient of friction (DCOF) Coefficiente di attrito dinamico	ANSI A137.1-2012	The Ceramic Tiles Institute identifies Tile Slip Resistant when SCOF ≥ 0,60			
			Static coefficient of friction (SCOF) Coefficiente di attrito statico	ASTM C1028-2007	Declared Classification of the pedestrian surface materials according to the Wet Pendulum Test	
					Pendulum Friction Test Metodo del Pendolo	AS/NZS 4586-2013, Appendix A (Four S rubber)

^(*) The permissible deviation, in % or mm, of the average size for each tile (2 or 4 sides) from work size (WS). Deviazione ammissibile, in % oppure mm, della dimensione media di ogni piastrella (2 oppure 4 lati) dalla dimensione di fabbricazione (WS).
^(**) The permissible deviation, in % or mm, of the average thickness for each tile from the work size thickness (WS). Deviazione ammissibile, in % oppure mm, dello spessore medio di ogni piastrella dallo spessore riportato nella dimensione di fabbricazione (WS).
^(***) The maximum permissible deviation from straightness, in % or mm, related to the corresponding work sizes (WS). Deviazione massima ammissibile di rettilineità, in % oppure mm, in rapporto alla dimensione di fabbricazione (WS) corrispondenti.
^(****) The maximum permissible deviation from rectangularity, in % or mm, related to the corresponding work sizes (WS). Deviazione massima ammissibile di ortogonalità, in % oppure mm, in rapporto alla dimensione di fabbricazione (WS) corrispondenti.
^(*) The maximum permissible deviation from centre curvature, in % or mm, related to diagonal calculated from the work sizes (WS). Deviazione massima ammissibile della curvatura del centro, in % oppure mm, in rapporto alla diagonale calcolata secondo le dimensioni di fabbricazione (WS).
^(*) The maximum permissible deviation from edge curvature, in % or mm, related to diagonal calculated from the work sizes (WS). Deviazione massima ammissibile della curvatura dello spigolo, in % oppure mm, in rapporto alle dimensioni di fabbricazione (WS) corrispondenti.
^(*) The maximum permissible deviation from warpage, in % or mm, related to diagonal calculated from the work sizes (WS). Deviazione massima ammissibile dello sverglamento, in % oppure mm, in rapporto alla diagonale calcolata secondo le dimensioni di fabbricazione (WS).
⁽¹⁾ Anti-slip performance is guaranteed at the time of delivery of the product. Le prestazioni anti-slip vengono garantite al momento della consegna del prodotto.
⁽²⁾ Determination of slip resistance of pedestrian surfaces; it does not cover sports surfaces and road surfaces for vehicles (skid resistance). Determinazione della resistenza allo scivolamento delle superfici pedonabili; non si applica alle pavimentazioni sportive ed alle pavimentazioni stradali veicolari.
^(*) For further details, please refer to outdoor design general catalogue. Per maggiori informazioni riferirsi al catalogo generale Outdoor Design.
^(*) Only for products with 20 mm thickness. Solo per prodotti di 20 mm di spessore.
^(*) P3 class on demand. Classe P3 su richiesta.



SUSTAINABILITY

In the environmental and economic sciences, sustainability is defined as the condition of development capable of ensuring the satisfaction of the needs of the present generation without compromising the ability of future generations to realize their own. Several international certifications guarantee that the Atlas Concorde products meet the criteria of sustainable construction, attesting to their low impact on the ecosystem, compliance with declared standards and attention to comfort.

SOSTENIBILITÀ

Nelle scienze ambientali ed economiche, la sostenibilità è definita come condizione di uno sviluppo in grado di assicurare il soddisfacimento dei bisogni della generazione presente senza compromettere la possibilità delle generazioni future di realizzare i propri. Diverse certificazioni internazionali garantiscono che i prodotti Atlas Concorde rispondono ai criteri del costruire sostenibile, attestandone il basso impatto sull'ecosistema, la conformità agli standard dichiarati e l'attenzione al comfort abitativo.

CERTIFICATIONS

In 1995 Atlas Concorde obtained **ISO 9001** quality certification for its products. It is an international recognition referring to the company's entire quality system, from the receipt of raw materials to their transformation, from the distribution of the product to their placement on the market. The environmental footprint of products (**PEF, Product Environmental Footprint**, according to Recommendation 2013/179/EU) is a measurement that, based on various criteria, indicates the environmental performance of a product or service over its lifetime, taking into account supply chain activities: from the extraction of raw materials, to the production, use, and end of life of the product. Atlas Concorde has a certified PEF. Atlas Concorde's PEF was verified by the DNV-GL certifying body. Atlas Concorde also has an EPD declaration, which attests to the environmental sustainability of its products. The **EPD (Environmental Product Declaration)** also assesses the life cycle of a product, from extraction to the factory gate, before it is transported and distributed for sale. Atlas Concorde's EPD declaration was certified by the independent certifying body EPD ITALY. Atlas Concorde has a **HPD (Health Product Declaration)** declaration, a complete report on the health characteristics of the finished product, compiled according to the HPD standard. Atlas Concorde has also drafted an FDES environmental declaration (Fiche de déclaration environnementale et sanitaire), this also having the purpose of transparently disclosing the product's impact, covering each phase from product extraction to production and finally laying and use.

CERTIFICAZIONI

Sin dal 1995 Atlas Concorde ha ottenuto per i propri prodotti la certificazione di qualità **ISO 9001**. Si tratta di un riconoscimento internazionale riferito all'intero sistema di qualità aziendale, dall'ingresso delle materie prime alla loro trasformazione, dalla distribuzione del prodotto alla sua immissione sul mercato. L'impronta ambientale dei prodotti (**PEF, Product Environmental Footprint**, secondo la Raccomandazione 2013/179/UE) è una misura che, sulla base di vari criteri, indica le prestazioni ambientali di un prodotto o servizio nel corso del proprio ciclo di vita, tenendo conto delle attività della catena di approvvigionamento: dall'estrazione di materie prime, alla produzione, all'uso e fine vita del prodotto. Atlas Concorde dispone di una PEF certificata. La PEF di Atlas Concorde è verificata dall'organismo di certificazione DNV-GL. Atlas Concorde dispone inoltre di una dichiarazione EPD, che attesta la sostenibilità ambientale dei prodotti. Anche la **EPD (Environmental Product Declaration)** valuta il ciclo di vita di un prodotto, dall'estrazione al cancello della fabbrica, prima che sia trasportato e distribuito per la vendita. La dichiarazione EPD di Atlas Concorde è stata certificata dall'ente di certificazione indipendente EPD ITALY. Atlas Concorde dispone della dichiarazione **HPD (Health Product Declaration)**, un report completo sulle caratteristiche di salubrità del prodotto finito, compilato secondo lo standard HPD. Atlas Concorde ha realizzato inoltre la dichiarazione ambientale FDES (Fiche de déclaration environnementale et sanitaire), anch'essa con lo scopo di rendicontare in modo trasparente l'impatto del prodotto, a partire dalla fase di estrazione del prodotto, passando dalla fase di produzione, fino alla posa ed all'utilizzo.

LEED V4

All Atlas Concorde porcelain floor and white body wall tiles can be used in projects that follow the guidelines of the **GREEN BUILDING COUNCIL**, which promotes the independent certification system **LEED BD&C v4** (Leadership in Energy and Environmental Design, Building Design & Construction), whose parameters establish precise criteria for the design and construction of buildings that are healthy, energy efficient and with low environmental impact. Ceramiche Atlas Concorde is a member of the US Green Building Council. All our products in porcelain stoneware and in white clay can therefore contribute to obtaining the LEED V4 rating of buildings, in relation to different areas: Sustainability of the Site, Materials and Resources, Internal Environmental Quality.

LEED V4

Tutti i prodotti in gres porcellanato e in pasta bianca Atlas Concorde possono essere utilizzati in progetti che seguono le linee guida del **GREEN BUILDING COUNCIL**, che promuove il sistema di certificazione indipendente **LEED BD&C v4** (Leadership in Energy and Environmental Design, Building Design & Construction), i cui parametri stabiliscono precisi criteri di progettazione e realizzazione di edifici salubri, energeticamente efficienti e a impatto ambientale contenuto. Ceramiche Atlas Concorde è membro dell'US Green Building Council. Tutti i nostri prodotti in gres porcellanato e in pasta bianca possono quindi contribuire all'ottenimento del rating LEED V4 degli edifici, relativamente a diverse aree tematiche: Sostenibilità del Sito, Materiali e Risorse, Qualità ambientale Interna.

MADE IN ITALY

The Made in Italy logo of Atlas Concorde stands for style, quality and ethics. Having firmly adhered to the Ethical Code promoted by Confindustria Ceramica, Atlas Concorde places the Made in Italy logo on all the products designed and produced in Italy, that is to say ceramic tiles, decorations and the majority of special trim tiles. Only a small amount of the latter is manufactured in Spain. Atlas Concorde products are produced using eco-friendly technologies, top quality and safe raw materials with the best working conditions guaranteed for our personnel. For these reasons, Atlas Concorde's Made in Italy is the expression of strong values such as style, design, product quality, and respect for the environment and the people who live in it.

Il marchio Made in Italy di Atlas Concorde è sinonimo di stile, qualità ed etica. Avendo aderito con convinzione al Codice Etico di Confindustria Ceramica, Atlas Concorde appone il marchio Made in Italy su tutti i prodotti studiati, progettati e realizzati in Italia, nella fattispecie tutte le piastrelle di ceramica, le decorazioni e la maggioranza dei pezzi speciali. Solo un ristretto numero di questi ultimi è fabbricato in Spagna. I prodotti Atlas Concorde sono inoltre realizzati con tecnologie rispettose dell'ambiente, utilizzando materie prime eccellenti e sicure, garantendo le migliori condizioni di lavoro. Per queste ragioni il Made in Italy di Atlas Concorde è espressione di valori forti quali stile, design, qualità del prodotto, attenzione all'ambiente e alle persone.



The Ceramics of Italy logo is an exclusive identification on ceramic products which have effectively been made in Italy by companies that are a part of the Confindustria Ceramica and who adhered to its Ethical Code. This Code, promoted and created by Confindustria Ceramica, commits all companies to communicate, clearly and with transparency, the origin of their products.

Il marchio Ceramics of Italy contrassegna esclusivamente i prodotti ceramici effettivamente realizzati in Italia da un'azienda associata a Confindustria Ceramica che ha sottoscritto il Codice Etico. Il Codice, redatto dalla stessa Confindustria Ceramica, impegna a comunicare con chiarezza l'origine dei prodotti.

www.ceramica.info



MADE IN ITALY. MADE TO EXCEL.

www.atlasconcorde.com



CERAMICHE ATLAS CONCORDE S.p.A.
Via Canaletto 141
41042 Spezzano di Fiorano (MO) – Italia

ATLAS CONCORDE USA, Inc.
117 Seaboard Lane - Suite 170
Franklin, TN 37067 - USA

ATLAS CONCORDE RUSSIA
Business centre "Meliora Place"
Prospekt Mira 6, 129090 Moscow – Russia

www.atlasconcorde.com

Copyright 2018 by Ceramiche Atlas Concorde S.p.A.
(Spezzano di Fiorano, MO - Italy)
Tipolitografia Pagani
April 2018